





Marais 36
2400, Le Locle
Switzerland
mpi@bluewin.ch

Phone: +41- (0)-32-9314045
email: mpi@mpi-ultrasonics.com
<http://www.mpi-ultrasonics.com>
<http://mastersonics.com>

AMMM generators

Can drive any kind of ultrasonic transducers: for cleaning, welding, sonochemistry, bonding, machining...

Without LCD	STANDARD FEATURES INCLUDE:	With LCD	
 <p>400W</p>	<ul style="list-style-type: none"> . Automatic Frequency Tuning . Digital Amplitude Control 	 <p>400W</p>	
 <p>100W</p>		<ul style="list-style-type: none"> . Ultrasonics Load Meter Scale 	 <p>1000W</p>
 <p>2000W</p>		<ul style="list-style-type: none"> . PLC I/O (Input/Output) Ports . Soft Start Overload Protection Circuitry . Load Regulation Circuitry 	 <p>2000W</p>
<p>Power available in 400W, 1000W and 2000W (any higher power on demand).</p>			

Item	Selection & Properties		
	AMMM-400 W	AMMM-1000 W	AMMM-2000 W
Power	max. 400 W	max. 1000 W	max. 2000 W
Frequency	20 kHz- 100kHz		
Amplitude	constant and load-independent amplitude at the transducer possible with: analog voltage, RS 485 interface		
Interfaces	<ul style="list-style-type: none"> . status LED's . PLC-interfaces . Remote support via RS485 		
Protected against	<ul style="list-style-type: none"> . overload . short circuit . over-temperature 		
Connectors on the rear of the generator	<ul style="list-style-type: none"> . line-connector . RF-connector (HV-BNC) . interface-connector Canon 15 . RS485 		
Mains:	216-240VAC 50÷60Hz		
Current consumption	dependant on the module max 7A		
Dimensions (mm)	250 x 210 x 80	270 x 250 x 135	435 x 380 x 100
Weight		4.4 kg	
Standards	CE-conformity		
Applications	welding, sonochemistry, bonding, cleaning, sieving, cutting, machining, atomizing, multi-frequency & wideband transducers...		

ATTENTION: A shielded control cable must always be used for the RS485-USB interface.

We can produce customized Ultrasonic Power Supplies of any higher power on demand.

Ultrasonic World Message

- 1. Our** ultrasonic power supplies are compatible or easily modifiable to drive almost any piezoelectric ultrasonic transducer presently used/known in High Power Ultrasonics Industry (of course, modifications in critical and demanding cases should be made in our labs).
- 2. We** have the largest and modifiable frequency-window controls (almost any frequency interval, compared to 1 until 2 kHz from competition).
- 3. We** can replace almost any industrial ultrasonic power supply that is presently available from competitors (of course, not immediately, but still after a very short time after we get necessary information from a client).
- 4. Our** ultrasonic power supplies are using advantages of dynamic load power regulation between series and parallel resonance (capturing even wider frequency intervals). We can operate any piezoelectric, ultrasonic transducer in its resonant, fixed frequency regimes, in any numerically selected operating frequency interval, and in many forced, arbitrary frequency-modulated wideband regimes.
- 5. We** implement (safe operating) internal scanning procedure in order to select the optimal operating regime and settings for certain ultrasonic transducer.
- 6. Our** Ultrasonic Power Supplies have smooth power and amplitude regulation. We are applying limitation of maxima load power, maximal transducer amplitude and maximal output voltage on piezoceramics. We are applying overheating, short-circuit, over-current and over-voltage protections.
- 7. We** can produce customized ultrasonic power supplies without power limitations (operating until 100 kHz or higher).
- 8. Our** standard line of Ultrasonic Power Supplies is operating on European main supply voltage input, being tolerable to input voltages from 200 Vac until 240 Vac, 50/60 Hz. We can easily produce the same Power supplies for other input voltages (115 Vac 50/60 Hz). Internally, all of our standard Ultrasonic Power Supplies have stabilized, universal voltage SMPS for control and logic modules operating from 95 to 265 Vac. We can also (optionally) apply high power PFC input for customized Power Supplies.

9. We have the largest number of settings regarding operating parameters and conditions controls, frequency modulations, forced and/or automatic resonance-regimes driving, applicable for all presently known Industrial Ultrasonics Applications (such as welding, cleaning, sonochemistry, materials processing, ultrasonically assisted metallurgy, bonding, sieving, cutting, machining, atomizing, driving multi-frequency & wideband transducers etc.). Nevertheless, it is good to know that the biggest challenge in operating different ultrasonic loads (and transducers) is related to the fact that all electrical adjustments and settings are completely related to properties of mechanical system we would like to drive. The same transducer (with different mechanical loading) can produce different output power at the same output voltage and frequency. In certain cases, it is necessary that the first-time modifications and settings be made in our labs. Systematically we are converging to design solutions for ultrasonic power supplies, which are close to universal, but there will always be a space when client will need our assistance. Until present, nobody is offering such options. In addition, we have internally adjustable compensating, inductive and capacitive components, adjustable voltage outputs etc.

10. Our Ultrasonic Power Supplies have all kind of modern industrial control options (PLC, PC software controls, LabView, ModBus, USB, analog input controls...). We can customize and introduce any other control option. Our ultrasonic generators can be controlled with:

- any kind of PLC
- analogue control signals from 0-10V
- amplitude variable and discrete signals
- on/off switching, error signals, etc
- or with RS485 based communications (we are giving the communication protocol).

11. Once after optimal settings are made (on certain of our ultrasonic power supplies, and for certain converter), there is almost no need to do anything more. Just use it on a usual way as using any other modern ultrasonic generator, and control only basic parameters (like timing, amplitude, energy etc.). There is no more need to use LabView software controls.

Literature: [Piezoelectric Transducers Modeling and Characterization \(e-book\)](#)

Load current and load voltage, Start-up, rising times until getting regulated and stable amplitudes

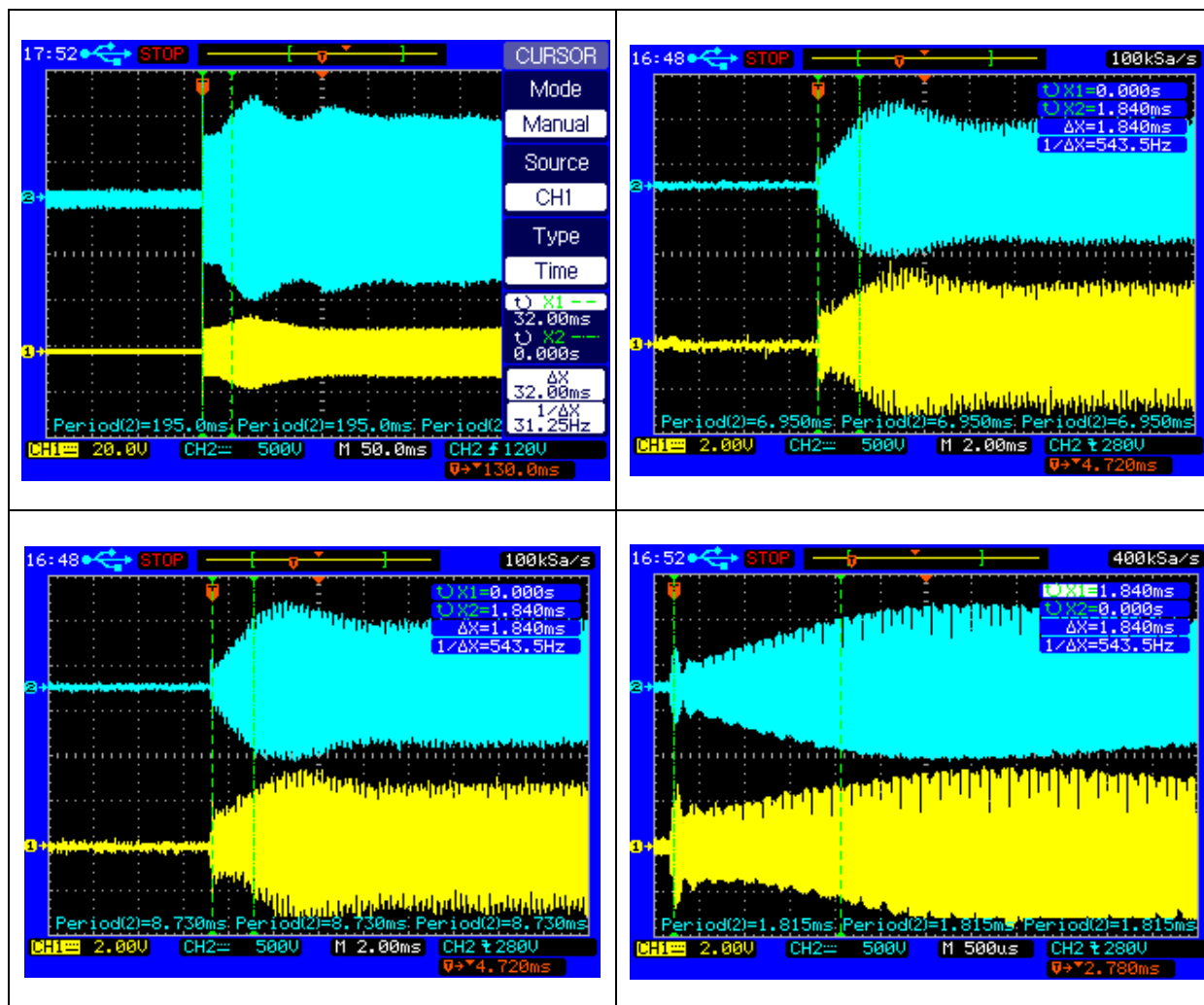

Measured transient time intervals (presented here) are in the range of 2 ms, enabling very fast welding and pulse repetitive regimes. Compare it with competition and you will see that we are for an order of magnitude faster.

INTRODUCTION

Please read these operating instructions carefully and follow them before installing or commissioning your product. Failure to observe these instructions can present a risk to life.

Units may be operated by trained personnel only.

Failure to comply with this will result in a loss of warranty rights.

The device may only be operated and maintained by personnel who have read and understood this operating manual and are familiar with the applicable legal regulations for accident prevention and workplace safety.

ASSEMBLY

In addition, ambient temperatures of over 30°C should be avoided.

Choose a suitable location that will protect the device from moisture, water, excessive sunlight and heat.

- ATTENTION:**
- Choose a location that will prevent steam or any other aggressive vapors from penetrating the device.
 - Over a period of time, chemically contaminated ambient air can lead to the device being irreparably damaged.

Power supply

The ultrasonic generator draws its power (230 V / 50 / 60 Hz) via the connection cable.



It has an internal main fuse (10 AF).

If you need to change the fuses, unscrew the top of the housing.

ATTENTION:

- For safety reasons, always disconnect the unit from the mains before changing fuses.
- Plug racks into earthed sockets only.
- Always replace blown fuses with new fuses of the same type.
- This should only be performed by qualified, skilled personnel.

Connections on the back of the generator**HF OUTPUT:**

Output of the HF voltage (possible to have different high voltage connectors).

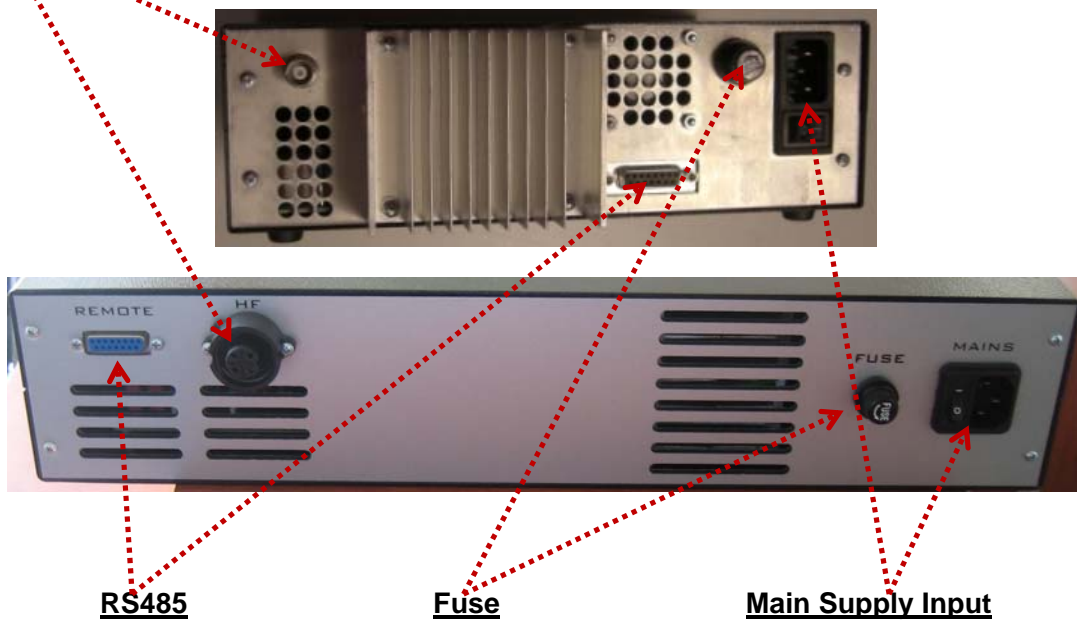
**ATTENTION:**

- Only use cables specified by the manufacturer.
- Use only shielded transducer connection cables.
- Connect the shielding to the PE conductor on the generator side.
- Only use cables with sufficient cross-section.
- Minimum wires cross-section: 1.5 mm².

Assignment of the 15-pole DSUB interface socket (RS485)



PIN No. on DSUB SOCKET Interface X1	Signal name	Description
1	+12 VOLT OUT	12 Volt for external use
2	POUT	Output 0 – 10 Volt = Power output 0 – 100 %
3	P-EXT.-IN	Input 0 – 10 Volt for power control
4	GND	Shared reference point = Ground
5/9	HF-DA-ERROR	Relay root (shared) for “HF-DA” and “ERROR”
6	HF-DA	Relay output “HF-DA”
7	ERROR	Relay output “ERROR”
8	A	A signal of RS 485 interface
9/5	HF-DA-ERROR	Relay root (shared) for “HF-DA” and “ERROR”
10	B	B signal of RS 485 interface
11	<> Nominal	Output for nominal value
12	FAN-ON	Monitoring output = 12 Volt when the fan is running
13	FS-24 V	Remote control input (with 12 – 24 Volt)
14	FS-GND	Remote control input (to GND)
15	GND	Shared reference point = Ground

ATTENTION: A shielded control cable must always be used for the RS485 interface.

-RS485 industrial interface is available on pin 8, 10.

(We can give our Interface protocol to interested clients).

-Otherwise generator could be controlled with on/off 12 to 24 volts signal on pins 13, 14.

-Output power could be controlled by 0-10V on pins 3, 4.

-All these features make our AMMM generator very flexible for controls by PLC, HMI or SCADA systems.

-Our new digital AMMM generator could be set at any operating frequency in the range 15 to 100 kHz with accuracy of 0.03 Hz* (of course ultrasonic transducer and load should be able to operate in a desirable frequency range...).

Interface Description (RS485)

1) Signal “+12 Volt Out”

DSUB PIN 1

A voltage of 12 V is available at this output. This voltage can be loaded with max. 100 mA and can, for example, be used to output a voltage for the function “HF-DA” and/or “Error”.

This voltage can also be used to switch on the generator on the input “FS-24 V”.

2) Signal “POUT”

DSUB PIN 2

At this output a voltage proportional to the power output of between 0 and 10 V

(= 0 % – 100 % power output) is available.

Reference point = “GND”.

3) Signal “P-EXT.-IN”

DSUB PIN 3

By connecting a voltage between 0 V and 10 V, the output of the generator can be set to between 0% and 100 % of its nominal amplitude or power.

Reference point = “GND”.

4) Signal “HF-DA ERROR”

DSUB PIN 5/9

Shared in/output for the internal relays “HF-DA” and “ERROR” (these PINs are connected internally).

5) Signal “HF-DA”

DSUB PIN 6

If the ultrasonic generator has been switched on via of the signals “FS-24 V”, “FS-GND” and is producing HF voltage (i.e. there is no malfunction), an internal floating relay contact is closed. (between PIN 6 und PIN 5/9)

The “root” of this relay contact leads through to a PIN 5/9 (these pins are connected internally) in the DSUB socket.

A voltage connected to Pin 5/9 can be switched through (max. 24 VDC / 100 mA).

Standard factory setting: Contact closed when the generator outputs HF voltage.

6) Signal “Error”

DSUB PIN 7

This is the output of an internal relay (root to PIN 5/9).

This relay reports generator malfunctions. This means that if the generator is switched on and, for some reason, the power output does not correspond to the set level, this relay is activated.

Factory default settings: Closed in the event of a malfunction. It is possible to change the polarity in the Settings menu under the heading I/O Polarities (“Error detect”).

An external voltage connected to “HF-DA-Error” can, of course, also be switched through here (max. 24 VDC / 100 mA).

7) Signal “FAN-ON” **DSUB PIN 12**

At this output, there is a control voltage (12 Volt) for monitoring the fan function when the internal fan is running.

8) Signal “FS-24 Volt” **DSUB PIN 13**

Switching on the generator (Ultrasound On) by connecting a voltage between 15 – 24 Volt between PIN 13 and GND (PIN 4/15).

9) Signal “FS-GND” **DSUB PIN 14**

Switching on the generator (ultrasound ON) with a relay contact or switch by connecting PIN 14 on the DSUB socket to GND (PIN 4 /15).

10) Signal “<> Nominal” **DSUB PIN 11**

Open Collector output: high signal if a window function is active and the generator is operated outside the window set; low signal if a window function is active and the generator is operated within the window set.

11) Signal “GND” **DSUB PIN 4, 15**

The GND signal is available on multiple pins of the DSUB socket.

It is the common reference point for all input and output signals.

Protocol for serial port communications for AMMM generators

Data format 115200 baud 8 bit no parity 2 stop bits
RS485 100 ohm standard line

Request for parameter

%06f<cr> request for frequency
%06d<cr> request for amplitude
%06s<cr> request for span
%06p<cr> request for phase
%06m<cr> request for sweeping
%06v<cr> request for sweeping frequency
%06g<cr> request for FSWM frequency
%06h<cr> request for FSWM period
%06l<cr> request for FSWM ratio
%06t<cr> request for smoothing
%06w<cr> request for PWM ratio
%06c<cr> request for output capacitor
%06?<cr> request for parameters

Answers

#02fxxxxx<cr> answer for frequency scale 1Hz
#02dxxxxx<cr> answer for amplitude scale 0.1%
#02sxxxxx<cr> answer for span scale 1Hz
#02pxxxxx<cr> answer for phase scale 5mV
#02mxxxxx<cr> answer for sweeping scale 1Hz
#02vxxxxx<cr> answer for sweeping scale 1Hz
#02gxxxxx<cr> answer for FSWM frequency scale 1Hz
#02hxxxxx<cr> answer for FSWM period in relative units
#02lxxxxx<cr> answer for FSWM ratio scale 1%
#02txxxxx<cr> answer for smoothing in relative units
#02wxxxxx<cr> answer for PWM ratio scale 1%
#02cxxxxx<cr> answer for output capacitor scale 1nF
#02?aaappppffffsvvvccc<cr> answer for parameters
 -aaa - amplitude scale 0.1%
 -ppp - phase scale 5mV
 -ffff - frequency scale 1Hz
 -s status
 0 - off
 1 - on
 2 - overheat
 3 - overcurrent
 -vvv actuator value of internal regulator scale 0.1%

-ccc power scale 0.1%

Settings

```
#06fxxxx<cr> set frequency scale 1Hz
#06dxxxx<cr> set amplitude scale 0.1%
#06sxxxx<cr> set span scale 1Hz
#06pxxxx<cr> set phase scale 5mV
#06mxxxx<cr> set sweeping scale 1Hz
#06vxxxx<cr> set sweeping frequency scale 1Hz
#06gxxxx<cr> set FSWM frequency scale 1Hz
#06hxxxx<cr> set FSWM period in relative units
#06lxxxx<cr> set FSWM ratio scale 1%
#06txxxx<cr> set smoothing in relative units
#06wxxxx<cr> set PWM ratio scale 1%
#06cxxxx<cr> set output capacitor scale 1nF
Answer for settings
><cr>
```

Remark - <cr> is ASCII code for 'Carriage return' hex code 0x0D decimal 13

Start generator

```
@06start<cr>
```

Answer for start

```
ok><cr>
```

Stop generator

```
@06stop<cr>
```

Answer for stop

```
ok><cr>
```

Write to eeprom memory

```
@06wr<cr>
```

Answer for write

```
ok><cr>
```

GENERATOR CONTROLS

Operator elements and display on the front panel



LED-on: Lights up when the device is being supplied with mains voltage correctly and the power switch is ON

LED-error: Lights up in the event of an error









ON/OFF button: The generator is switching on and off by pressing this button.



Menu - Encoder / Select: For setting and entering values

The LCD

<p>Initial screen Start Up screen is shown after powering the generator.</p>	
<p>Sweeping (=) SW (=) Periodical, harmonic frequency sweeping Here, the encoder can be used to adjust the depth of linear, harmonic and periodic sweeping (around optimal operating frequency). It is adjustable from 0 to 1 kHz. This periodical frequency modulation is evenly distributing ultrasonic activity and minimizing influence of standing waves.</p>	
<p>Amplitude Display shows the set value of output power and its performance on "A" bar. From 0% to 100% of nominal generator power. During initial testing of new sonotrodes, set the amplitude to some low value (example: 5% to 10%).</p>	
<p>Start Frequency Here encoder can be used to set the initial operating frequency (which is between f-s and f-p, but closer to f-p). Here, the encoder can be used to adjust the starting frequency. Start frequency f-start can be changed/adjusted also during the generator operation. The generator has an automatic "frequency tuning" inside the frequency capture range (see the explanation which follows). The frequency capture range can be set by "Span" parameter from 0 to 1 kHz (below the start frequency, towards lower frequencies: f-capture = f-start - Span). The operating resonant frequency of ultrasonic system must be found in advance (before operating the system full-power), performing initial low power scan-testing with the generator Lab View software. This frequency will be found somewhere below the frequency where scanned generator current is maximal, and where the scanned phase function is smoothly rising from its minimal value towards its maximum, when in the same time, the frequency is going towards lower frequencies). The frequency area which is covered (by this type of regulation) depends on the device type (it is impedance-characteristic dependent: f-capture = f-start - Span).</p>	

<p>Span Selected frequency window where AMMM generator is automatically searching for an optimal operating point.</p>	
<p>Memory After turning the encoder, the display returns to display the volatility and settings for all parameters are stored in memory.</p>	

When a PC (through communication cable and RS485 interface) is connected to the generator, PC automatically starts regulating the generator with higher priority. When a PC is disconnected, it is immediately possible to use regulations on the front panel of the generator.

For safety reasons, when ultrasonic system is started first time, when (any or all of): ultrasonic transducer, booster, sonotrode etc. are unknown, or new, or replaced, set the **Amplitude** value to certain low value (for instance on 5%). In addition, set sweeping **SW** to certain average value between 20% and 50 %. Then start low power testing and scanning in order to find the best operating frequency interval.

After all initial settings are made (using a PC and supplied Lab View software), Ultrasonic Generator can be activated, and it will start driving ultrasonic converter by pressing **ON/OFF** button (which is on the front panel). Do not start the generator until all initial settings are verified and set to safe (low power and low risk) positions.

Frequency-capture range = Span:

This is the safe-operating, low-power frequency scanning of ultrasonic load (Ultrasonic converter + booster + sonotrode + etc.), where the scanning display would visualize the phase difference versus frequency between a load current and load voltage (red color curve), and input DC generator current (white color curve). Such frequency scanning is realized using the Lab View software supplied with ultrasonic generator). In order to make scanning, personal computer with installed Lab View software should be connected to ultrasonic generator through RS485 interface.

Initially (first safe-operating, low power frequency scanning) should be selected to cover only the expected operating frequency range of ultrasonic system.

In here-described scanning, frequency is smoothly changing towards lower values, starting from f-start and finalizing scanning at the frequency which is equal to f-start – Span. Span is the frequency interval we select as a frequency-capture range (in Lab View Software).

For instance, if ultrasonic system consists of: 20 kHz ultrasonic converter + 20 kHz booster + 20 kHz sonotrode (where not all of them are exactly tuned to operate on 20 kHz, or to have single operating frequency of 20 kHz), we know that we should expect the resulting, central operating frequency of such system to be somewhere close to 20 kHz, and consequently, we could select the scanning frequency range to be between 20 and 21 kHz (meaning f-start = 21 kHz, and Span = 1 kHz). Of course, another relevant example could be to select such frequency scanning between 19.5 kHz and 20.5 kHz (meaning: f-start = 20.5 kHz, Span = 1 kHz). Later (during scanning), the Lab View software will search and find real, average operating frequency somewhere inside of the area covered by scanning).

When/where generator input DC current (during such scanning) is reaching certain relative maximum (at certain frequency), this is indicating that ultrasonic load is also consuming certain power, and/or increasing its oscillating activity. This is the reason why we are taking such DC current maximum as the (upper) reference point for frequency scanning. In reality, this is also related to impedance curve of ultrasonic system under testing, since empirically we know that central operating frequency of a stable operating regime of ultrasonic system (in AMMM regime, under wideband frequency sweeping) should be below the frequency when the input DC current is reaching its maximum. This is also the reason to select an initial f-start just below the frequency where DC current is reaching maximum, and where the phase-difference function has its minimum (with a tendency to grow towards lower frequencies).





In the next step (next safe-operating frequency scanning) we should select new (shorter) value for Span to cover only the closest part of the phase-curve (red color), which is showing the part of phase-difference curve starting from certain minimal value until its first maximal value (below the frequency where input, DC generator current is maximal). New f-start will be again at the point where the phase curve is minimal.

This way, we will visualize mentioned part of the phase difference curve on a larger display, and we will be able to estimate the frequency which is in the middle of that frequency interval, and which is approximately equal: $f\text{-start} - 0.5(\text{Span})$. Later, real AMMM operating frequency regime (under automatic regulation found by internally implemented hardware and software) will find its average or central operating frequency (inside of the new **Span** interval) and we will be able to perform/set large frequency sweeping around that frequency (in both directions). One of examples showing such experimental frequency Span determination of the most promising AMMM operating zone will be presented later.

AMMM Generators Software

Please follow initial steps:

- Go here and download necessary software files (MS Windows XP,32 bits):
http://www.mastersonics.com/documents/mmm_basics/mmm_power_supplies/AMMM/
Comment: Create AMMM (directory) box on a PC desktop that will be used to control your AMMM generator. Place inside of the AMMM box the following files:

Name ▲	Size	Type	Date Modified
 amm	1 KB	Registration Entries	07.11.2009 13:39
 ammm	1'469 KB	Application	01.12.2009 13:28
 ammm	3 KB	Configuration Settings	01.12.2009 13:28
 ammm.aliases	1 KB	ALIASES File	01.12.2009 13:28
 CDM 2.04.06	2'160 KB	Application	15.09.2008 06:59



- Install, if not already installed, USB driver (CDM 2.04.06.exe). Click-on [CDM2.04.06.exe](#) () and this will install RS485 driver.

If necessary, install the latest driver for USB to RS485 adapter (take the driver here: <http://www.ftdichip.com/FTDrivers.htm>). Connect ultrasonic generator to a PC using the RS485-USB adapter (supplied with the AMMM generator; -see the picture below). Switch ON the main switch of your AMMM ultrasonic generator (This is only a main supply power input; -for instance 230 Vac, 50/60 Hz. Ultrasonic output power is still not activated). PC will not connect to ultrasonic generator if generator is not powered by main supply input.



3. Activate **RS485-USB** connection line between your AMMM generator and your PC (select proper, active serial, COM port, Open Serial port dialog, rescan/refresh if necessary... until LEDs on the **RS485-USB** box will start blinking):

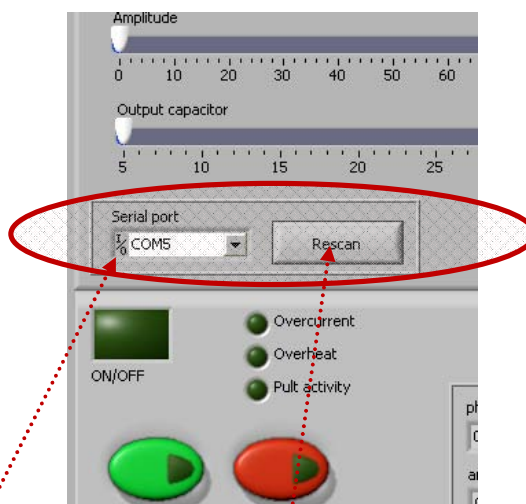

In the lower left corner of the software interface (**First TAB**) it is necessary to select a free/available **COM** port and/or press **Refresh/Rescan** (this will activate the connection between the generator and a PC; -see pictures below). If necessary, make Refresh again (or restart generator, exit/close and activate again ammm.exe, unplug and plug cables... until RS485-USB connecting line is activated). Lab View software will properly select relevant port for realizing RS485 communications (or if this is not the case, see which serial port is open and available, and activate it manually in the upper left corner of user-interface software).

For double checking (regarding COM port selection) go to Control Panel (MS Windows XP) to verify which COM port is assigned to USB-RS485 adapter (see the picture below; in this example, COM 4).

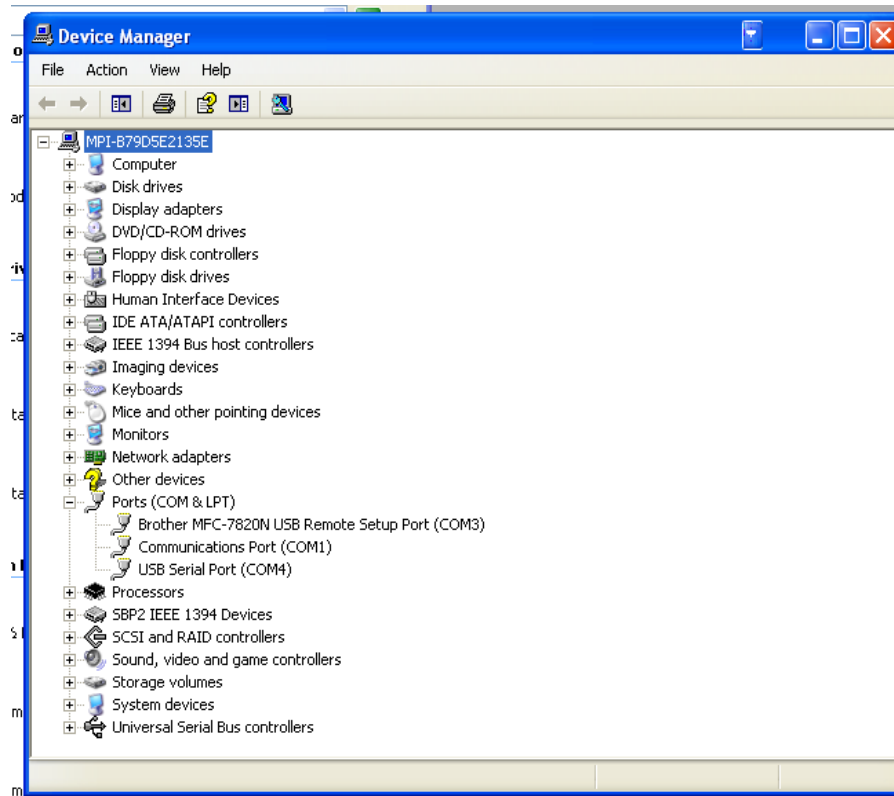

Ultrasonic generator is still not delivering output ultrasonic signal.

4. Install “**NI_Runtime8_5**”, LabVIEW runtime to a PC/laptop (Windows XP, 32-bits), which will be used to control your WELDING ultrasonic generator (see for software here: <http://joule.ni.com/nidu/cds/view/p/id/861/lang/en>). Verify that the VISA serial port driver for Labview is installed properly (it should be automatically installed with NI runtime software). To be sure that you will have the best installation for serial ports communication, install (in addition) NI-Serial 1.7-Windows/2000/XP. Take the software from here: <http://joule.ni.com/nidu/cds/view/p/id/533/lang/en>
5. Double click on the file **amm.reg** () which adds all adjustments for AMMM software on your computer.
6. Find MS-Windows software “**amm.exe**” on a PC and start it (take the AMMM LabView software from here: http://www.mastersonics.com/documents/mmm_basics/mmm_power_supplies/AMMM/).

When a PC (through communication cable and RS485 interface) is connected to the generator, PC automatically starts regulating the generator with higher priority. When a PC is disconnected, it is immediately possible to use regulations on the front panel of the generator (LCD + rotary encoder + small ON-OFF = start-stop button). Of course, AMMM generators can also be externally controlled using a PLC, or analog controls.

For safety reasons, when ultrasonic system is started first time, when (any or all of): ultrasonic load (transducer, booster, sonotrode) are unknown, or new, or replaced, set the **Amplitude** value to certain low value (for instance on 10%). In addition, set sweeping **SW** to certain average value between 0.1 and 0.3 kHz. Then start low power testing and scanning in order to find the best operating frequency interval. Forced oscillating regimes also have certain preferable, optimal, best-compromising operating frequency intervals, and we need to find the optimal mean frequency for certain of such intervals (which is showing something significant regarding our application).

-After activating “**ammm.exe**” software ( ammm.exe) you will see the following LabVIEW user interface for controlling AMMM generators (which has 3 software settings TABs):

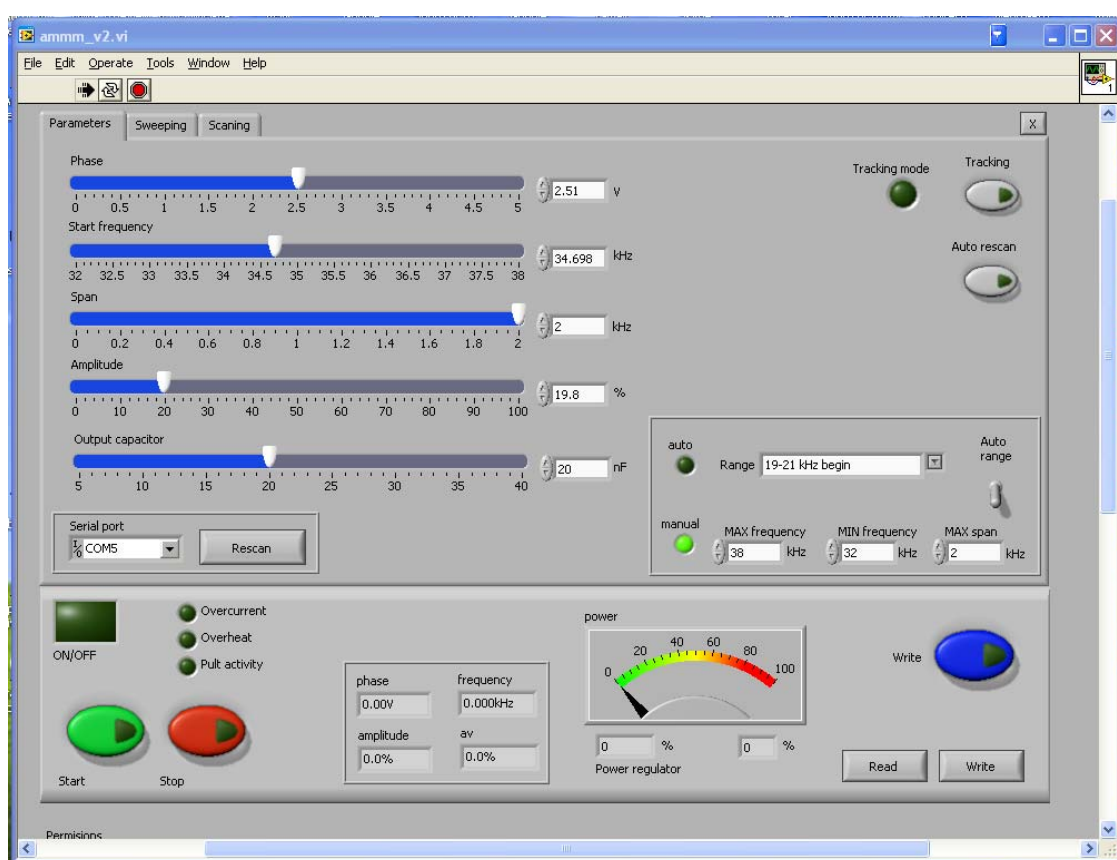

PARAMETERS & BASIC SETTINGS

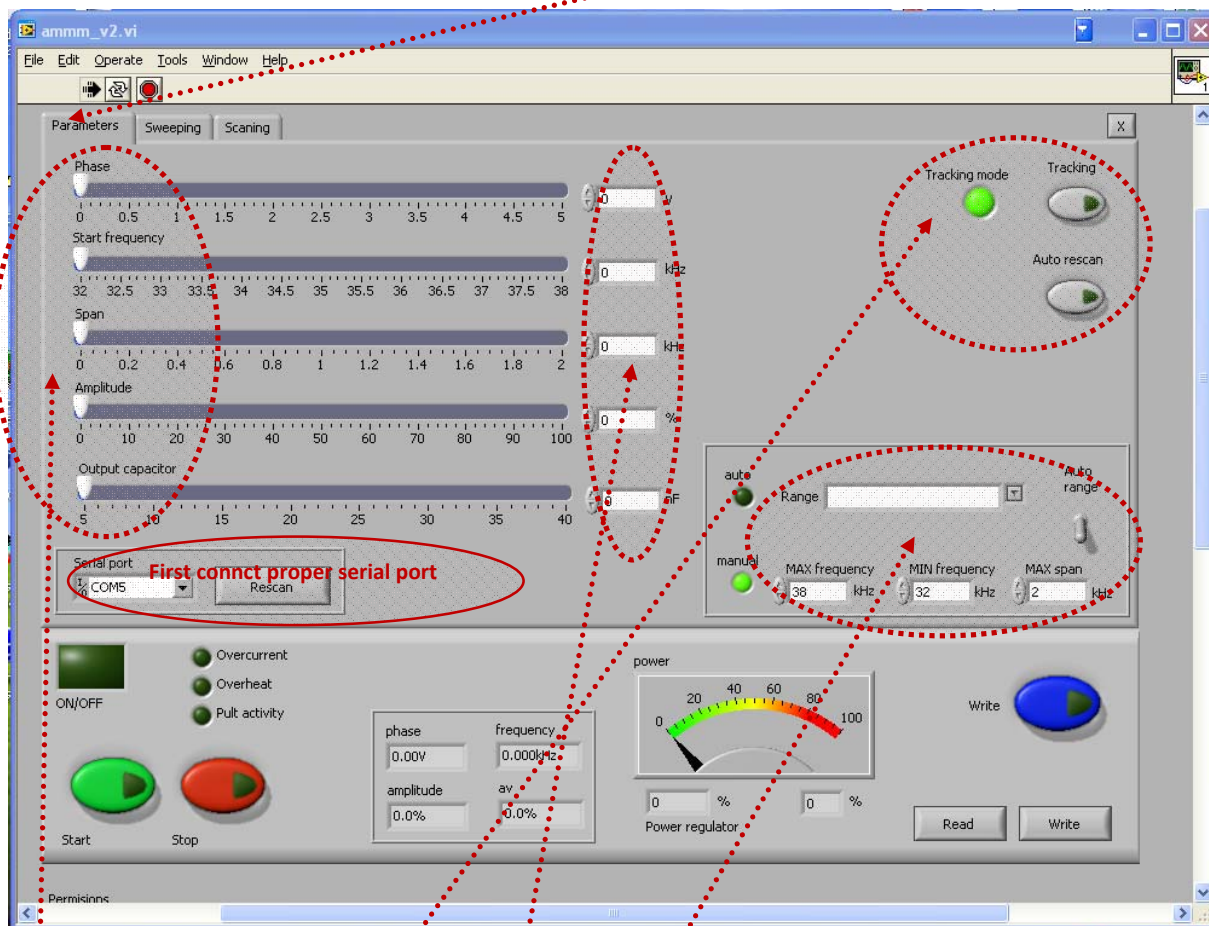

Principal software user-interface for controlling AMMM generators: First TAB

Phase difference settings (after scanning): optimal 2.5 v; -acceptable from 1 V until 3.5 V

Start frequency selection: Usually just above parallel resonant frequency of the transducer

Span (=) operating frequency interval selection (=) Localized inside (Start frequency – Span)

Amplitude (=) oscillating mechanical amplitude selection

Output capacitor (=) Parallel capacitance added to the transducer capacitance (select it first).

Numerical, manually editable fields (for arbitrary selections of operating frequency intervals which are inside of operating domains of AMMM generators (should be selected in advance).

Tracking: If **Phase** is set to 0 (zero), amplitude **tracking mode** is ON (activated), or it can be activated by pushing the button "**tracking**"

Auto rescan: If we are using in the same time a PC LabVIEW software and LCD rotary encoder controls, auto rescan will be activated, meaning generator will automatically make new scanning in order to update all settings values.

Output capacitor

Software selectable **Output capacitor** = $C_{\text{compensating}}$ is related to the output ultrasonic load circuit, and it is optimizing transducer impedance matching with the ultrasonic generator. When capacitance is selected properly, ultrasonic load will produce maximal output power on certain resonant frequency of connected ultrasonic transducer (see the picture below). Select also proper frequency **Range** that corresponds to applied ultrasonic transducer.

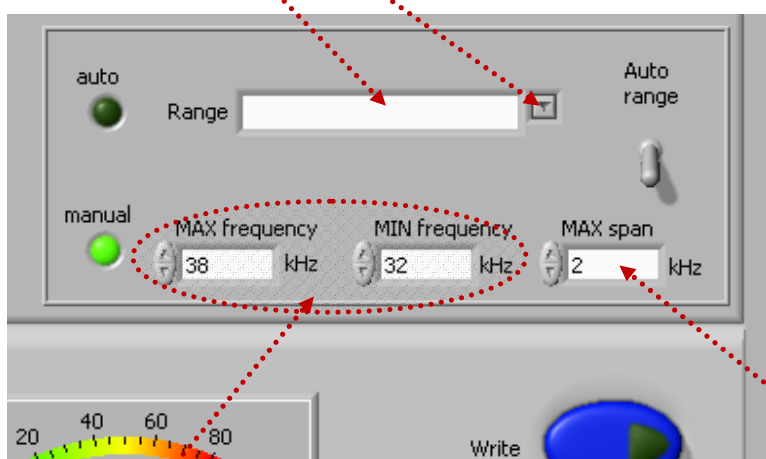
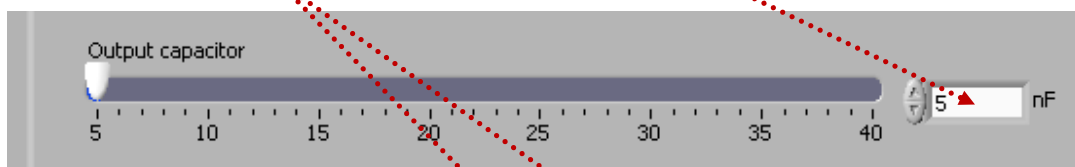

By default, automatically, we have 1 kHz wide **Max. Span**, but manually we can select and type **another value**.

MAX frequency & MIN frequency corresponds to end-values of the **Start frequency** slider (for instance, here 32 and 38 kHz).

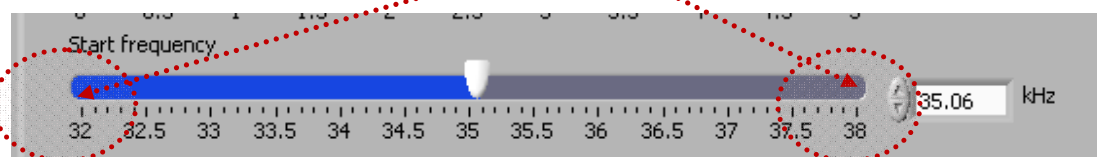

For simplified logical understanding (of such resonant matching), we can imagine that what we connect to the secondary side of the output ferrite transformer is a simple, serial L-C (inductance + certain capacitance) circuit. Ultrasonic converter is connected in parallel to the capacitance of mentioned serial L-C circuit.

Inside of the generator, series compensating inductance is fixed (and has two values internally selectable by jumpers): usually it is 1 mH for most of high power transducers operating around 20 kHz, and 0.5 mH in cases of higher frequency transducers (operating around 40 kHz and higher).

In order to adjust the load impedance to operate optimally on certain operating frequency $f_{\text{transducer}}$, we will effectively increase capacitance of the transducer by adding different, compensating parallel capacitances $C_{\text{compensating}} = \text{Output capacitor}$, this way creating necessary equivalent capacitance C_{eq} . Internally, AMMM generator has 8 values of selectable combinations of $C_{\text{compensating}}$ (in steps of 5 nF, such as: 5, 10, 15, 20, 25, 30, 35, 40 nF). Maximal capacitance of 40 nF can be connected in parallel to certain ultrasonic transducer. Inside of the generator (by default), there is always 5 nF capacitance, installed in parallel connection to an output transducer (which cannot be changed or disconnected by LabVIEW software). Only maximum of 35 nF can be added parallel to a transducer by LabVIEW software. This will create the total added capacitance that will go until max. 40 nF (non counting capacitance of the transducer). When we set by LabVIEW software the value of 40 nF, this will show that 40 nF is added in parallel to ultrasonic transducer (5 nF which are always there, and 35 nF which are added by software).

Mathematical formula for calculating necessary parallel capacitance (which should be added to transducer) is:

$$\left\{ \begin{array}{l} f_{\text{transducer}} = \frac{1}{2\pi\sqrt{LC_{\text{eq}}}} = \frac{1}{2\pi\sqrt{LC_{\text{eq}}}} (=)[\text{Hz}] \\ L = L_{\text{compensating}} = 1\text{mH} = 10^{-3}\text{H (or } 0.5\text{mH)} \\ C_{\text{eq}} = C_{\text{transducer}} + C_{\text{compensating}} = \frac{1}{4\pi^2 L f_{\text{transducer}}^2} (=)[\text{F}] \\ C_{\text{compensating}} (=) \text{externally added capacitance} \end{array} \right\} \Rightarrow \left\{ \begin{array}{l} C_{\text{compensating}} = C_{\text{eq}} - C_{\text{transducer}} = \frac{1}{4\pi^2 L f_{\text{transducer}}^2} - C_{\text{transducer}} \\ C_{\text{compensating}} = \frac{1000}{4\pi^2 f_{\text{transducer}}^2} - C_{\text{transducer}} \end{array} \right\}$$

Example:

$$\left\{ \begin{array}{l} f_{\text{transducer}} = 20000\text{Hz} \\ C_{\text{transducer}} = 20\text{nF} = 20 \cdot 10^{-9}\text{F} \\ L = 1\text{mH} = 10^{-3}\text{H} \end{array} \right\} \Rightarrow \left\{ \begin{array}{l} C_{\text{eq}} = 20 \cdot 10^{-9} + C_{\text{parallel}} = \frac{1}{4\pi^2 L f_{\text{transducer}}^2} = 60\text{nF} \\ C_{\text{compensating}} = C_{\text{eq}} - C_{\text{transducer}} = (60 - 20)\text{nF} = 40\text{nF} \end{array} \right\}$$

We can measure C_{eq} (inside of AMMM generator, on its output; -parallel to a connected transducer) and compare it with calculated value for C_{eq} in order to be sure that proper

equivalent capacitance is reached (or to be sure that proper parallel capacitance $C_{\text{compensating}}$ is connected to the transducer). Parallel capacitance $C_{\text{compensating}}$ (until 40 nF) is software selectable in AMMM generators (with LabVIEW software [ammm.exe](#)). Parallel capacitance can also be added in some other values, manually, by soldering specific capacitors (inside of the generator; -only for experts). **Every time when we (manually) change $C_{\text{compensating}}$ = Output capacitor by LabVIEW software, we need to stop the generator, since **Output capacitor** will not be automatically changed in real time when ultrasonic converter is powered by ultrasonic frequency, high voltage signal. When we stop the generator, software selected output capacitor command will activate internal relays and apply selected capacitor, and after that we can start the generator (in other words, compensating capacitor can be changed only when ultrasonic transducer is not operating; -generator is not producing high voltage output).**

Calculated value of $C_{\text{compensating}}$ presents only an approximated and maximal target value of capacitance that can be added in parallel to ultrasonic transducer (that we know how far we can go). In reality, when we make such capacitive impedance matching, we should start (testing ultrasonic transducer when operating in real loading conditions) from minimal value of $C_{\text{compensating}}$ (which is 5 nF). Then, we should gradually increase it until calculated value, or better to say until the other, lower value (which could be below calculated $C_{\text{compensating}}$), until we get optimal operating conditions on ultrasonic load. Optimal operating conditions are related to: reaching maximal load power on ultrasonic transducer, reaching maximal and safe operating voltage on piezoceramics, while still keeping automatic amplitude control and automatic or regulated frequency tracking.

In order to get sufficiently high and still safe operating conditions on ultrasonic load it is recommendable to start with minimal output voltage value on the secondary side of the output ferrite transformer (by connecting proper jumper which corresponds to minimal output voltage). If maximal ultrasonic loading power is still not high enough, we will increase output voltage on the ferrite transformer (by selecting the next value), and this will automatically increase maximal voltage on ultrasonic transducer. We need to be careful that voltage on piezoceramics has its safe limits, and that we need to operate below maximal acceptable voltage (which is usually until 200 V-rms per every millimeter of piezoceramics thickness).

When performing low power scanning (using our LabView software), in order to find or estimate optimal frequency range of certain transducer, compensating capacitance should be set on minimum (= 5 nF).

WARNING (only for experienced and experts)

In cases of new ultrasonic transducers resonant matching (first time testing and tuning) it is important to be very careful with the output voltage on ultrasonic transducer. 100% amplitude (in the software settings) is equal to maximal safe operating and acceptable voltage over the transducer (measured directly on piezoceramics). The RMS voltage should be measured directly on the transducer during all impedance matching and manipulations with output voltages on the output ferrite transformer. Output ferrite transformer has 3, jumper-selectable voltage outputs in order to be able to adjust maximal safe operating voltage. Special high-voltage/high-frequency, wideband RMS voltmeter should be applied when measuring voltage on the transducer (also oscilloscope with differential, isolated channel inputs for high voltage applications).

If transducer has piezoceramics which are 5 mm thick (each of them), maximal RMS voltage on such transducer can be 1000 V (= 1000 x 1.41 V - peak. If transducer has piezoceramics which are only 1 mm thick (each of them), maximal applied RMS voltage on it should not be higher than 200 V (= 200 x 1.41 V – peak).

Be sure you are working in the “CONTINUOUS MODE” - NO SWEEPING is allowed (of course, no FSWM, too); - Second TAB, lower right corner (when performing first time scanning, tuning and matching of new transducer).

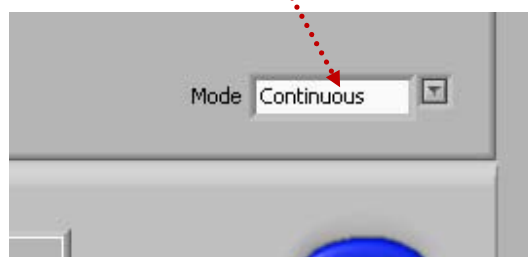

When performing low power scanning (using our LabView software), in order to find or estimate optimal frequency range of certain transducer, compensating capacitance should be set on minimum (= 5 nF).

Examples for calculating compensating capacitance:

C transducer [nF]	C compensation [nF]	L compensa tion [uH]	F[kHz]
3	5	500	100.71
3	10	500	71.21
3	15	500	53.08
3	20	500	50.35
3	25	500	45.04
3	30	500	41.11
3	35	500	38.06
3	40	500	35.61
3	45	500	33.57
3	5	1000	71.21
3	10	1000	50.35
3	15	1000	41.11
3	20	1000	35.61
3	25	1000	31.85
3	30	1000	29.07
3	35	1000	26.92
3	40	1000	25.18
3	45	1000	23.74
20	5	1000	71.21
20	10	1000	50.35
20	15	1000	41.11
20	20	1000	35.61
20	25	1000	31.85
20	30	1000	29.07
20	35	1000	26.92
20	40	1000	25.18
20	45	1000	23.74

Literature: [Piezoelectric Transducers Modeling and Characterization \(e-book\)](#)

FREQUENCY MODULATIONS OF AMMM GENERATORS

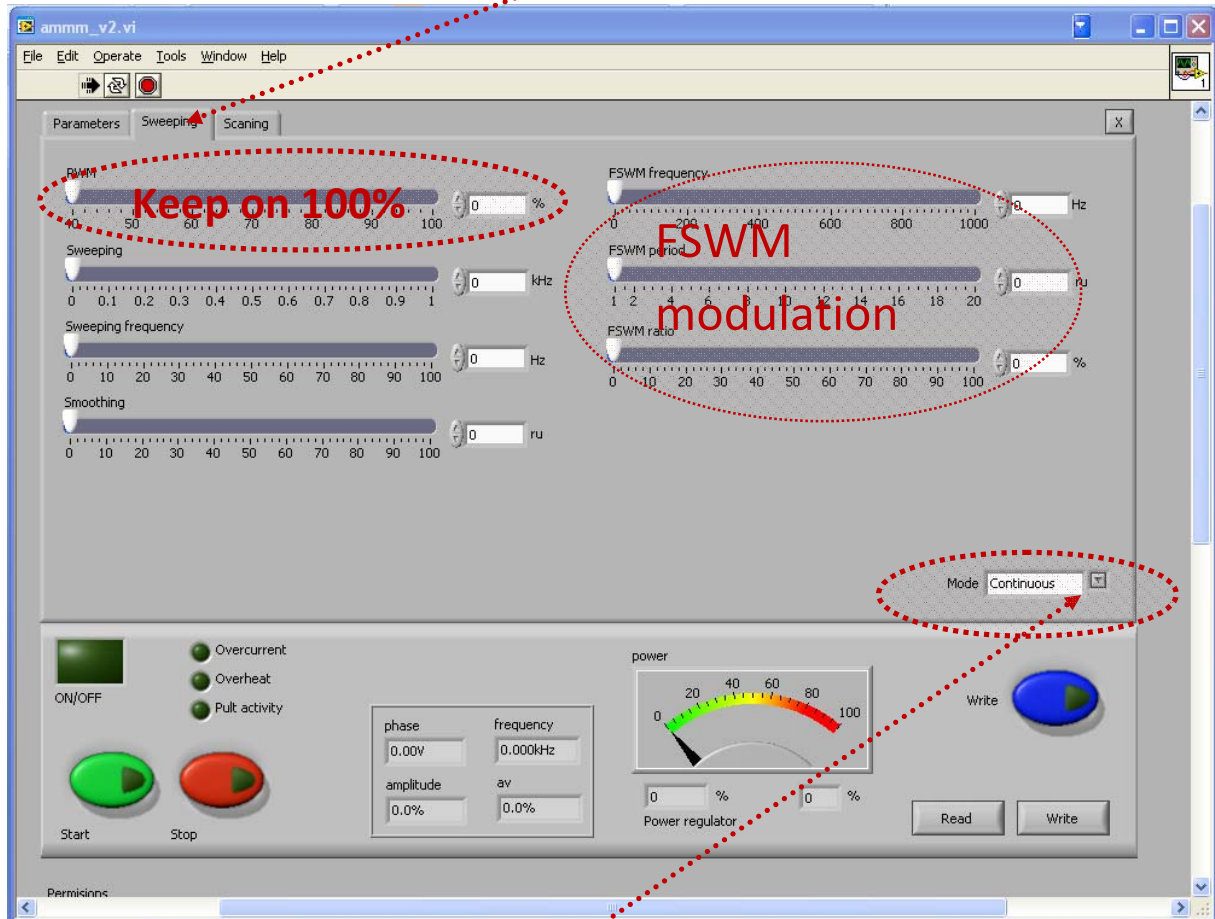

Principal software user-interface for controlling AMMM generators: Second TAB

AMMM generators have different frequency and time domain modulations. In order to select if operating regime will be continuous or frequency modulated, **one of options should be activated here**.

See explanations about modulations on the following pages:

It is possible to apply different frequency modulations on carrier operating frequency of AMMM generators, as for example:

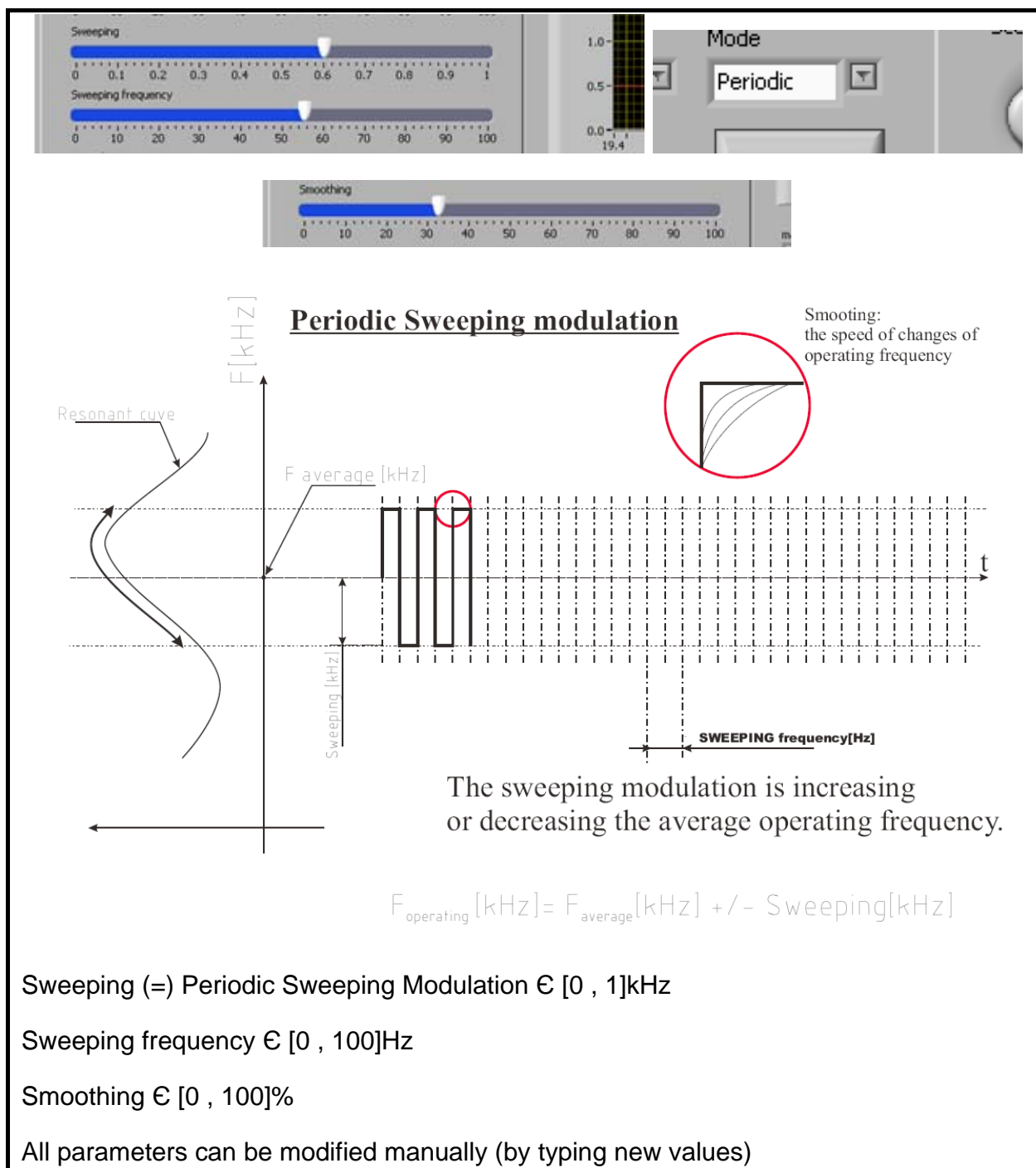

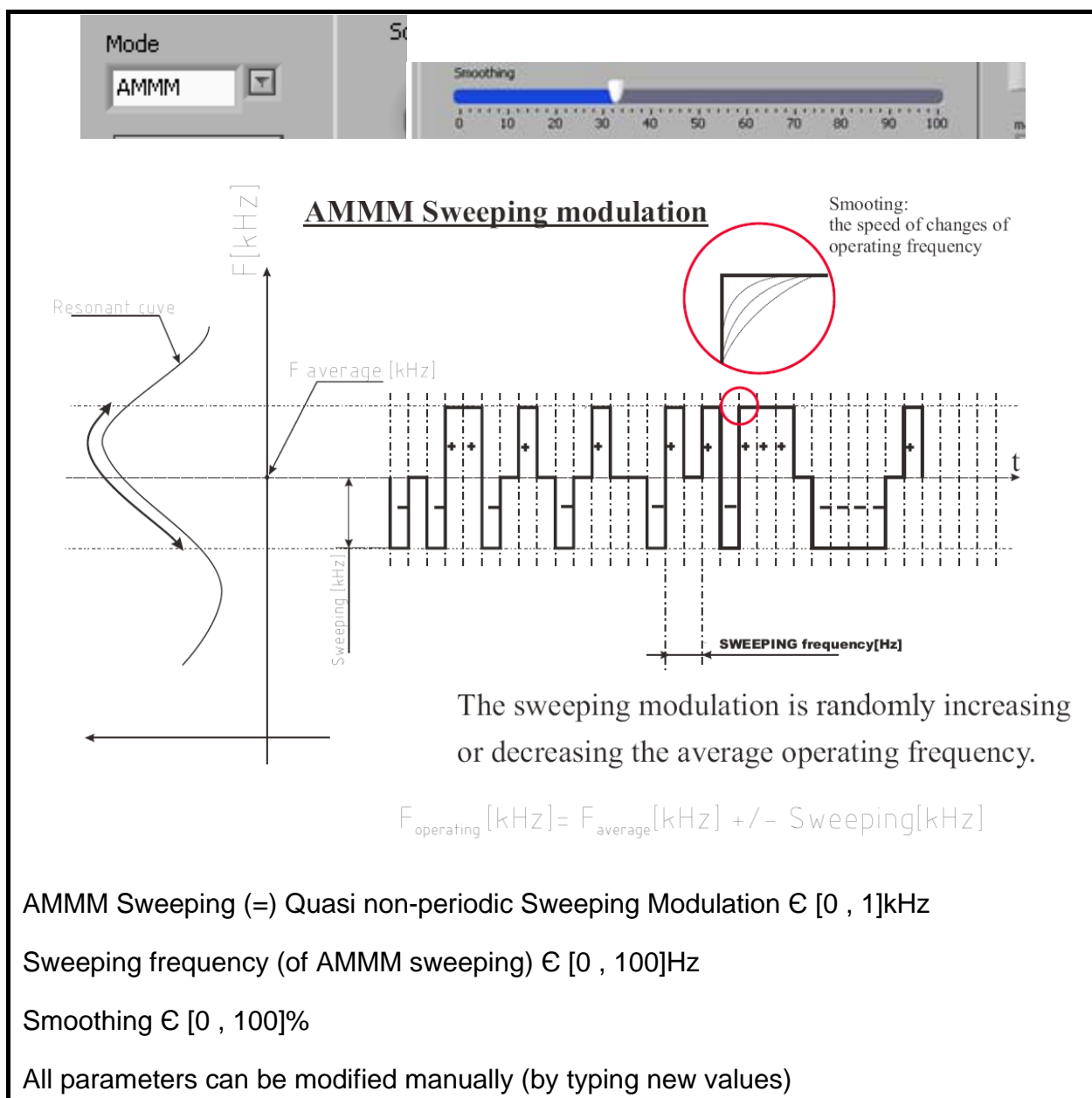

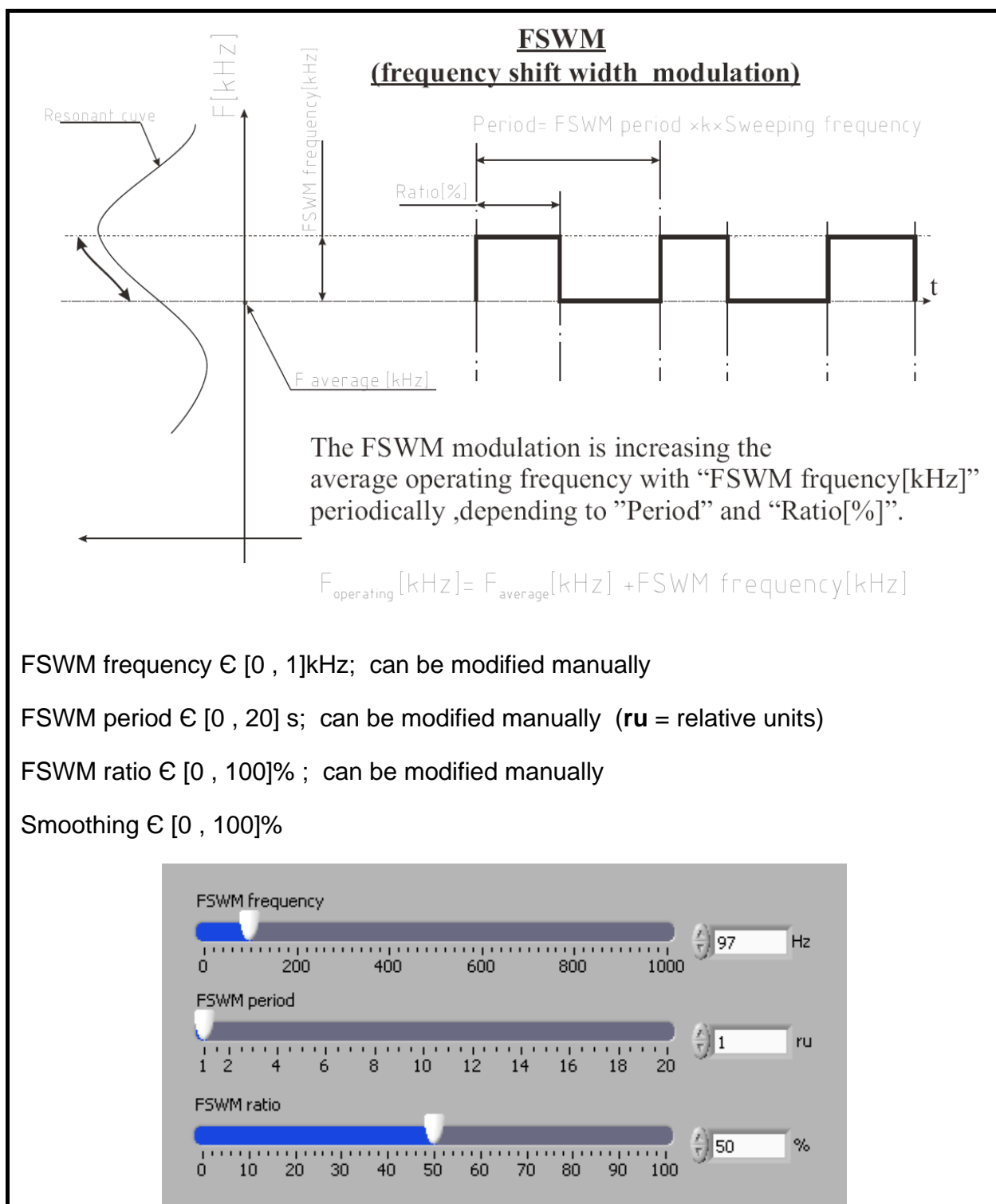

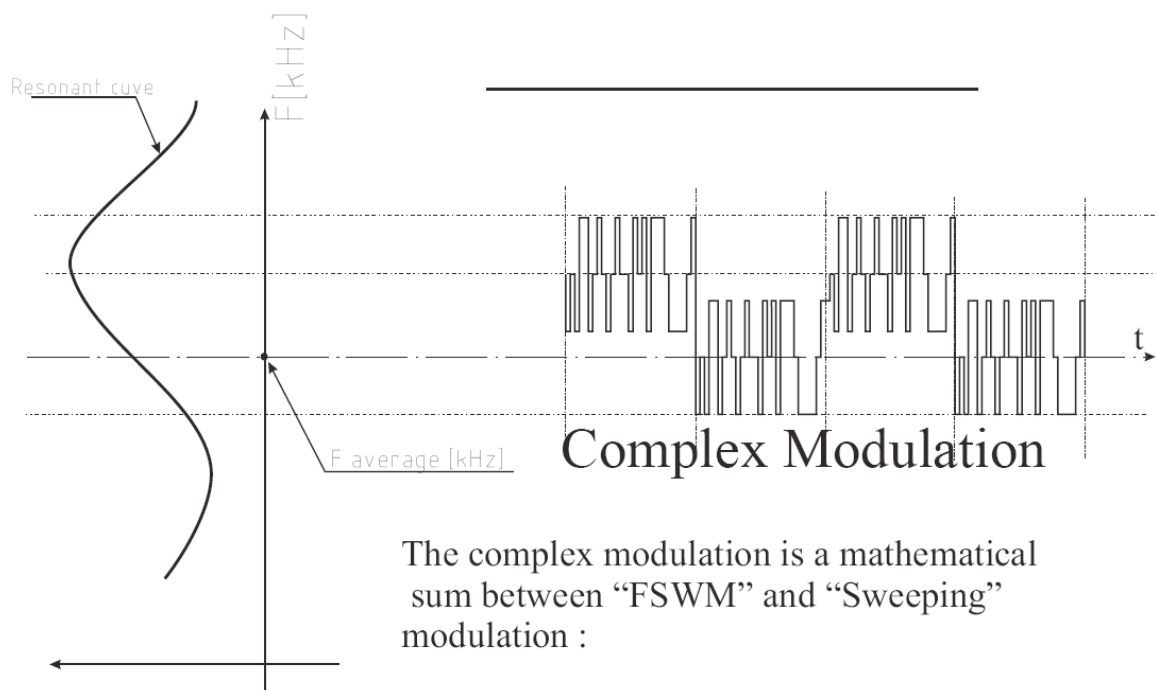
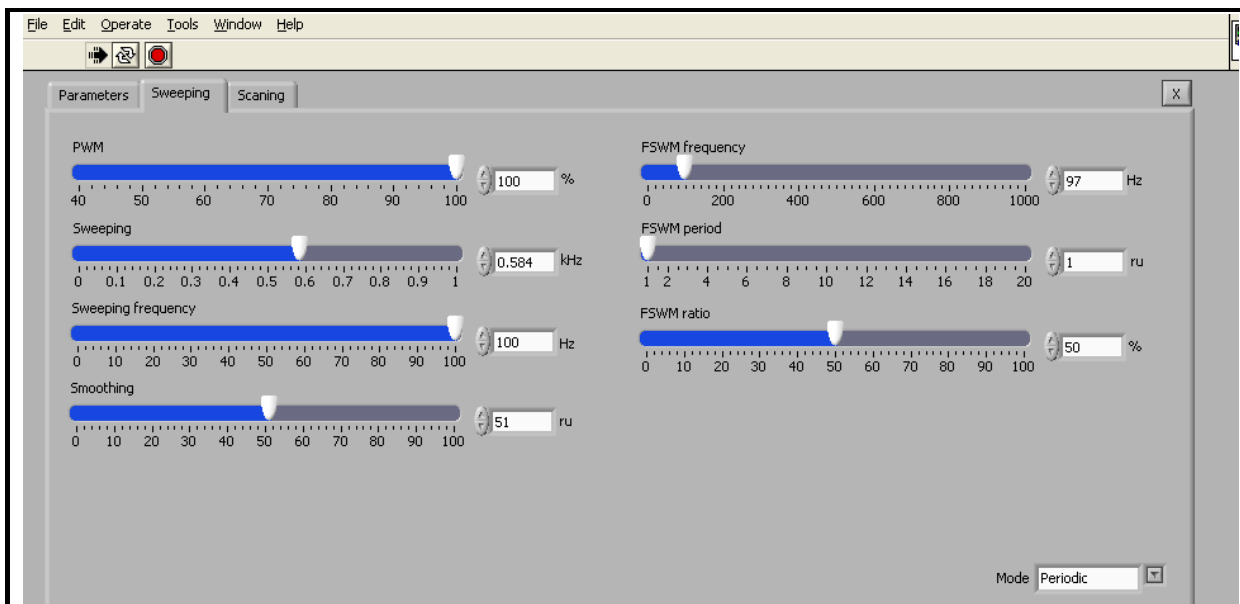

$$F_{\text{operating}} [\text{kHz}] = F_{\text{average}} [\text{kHz}] + \text{FSWMRange} [\text{kHz}] + /- \text{Sweeping Range} [\text{kHz}]$$

Blue – Write button: After scanning, when all settings are properly and optimally made (even made manually during operating the generator, or on any other way), we need to save such settings in internal generator memory using **Blue Write button**. This way, after switching the generator OFF and ON, last memorized settings will be used.

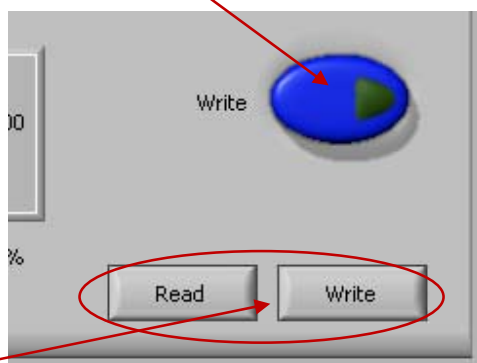

Read – Write options: After all settings are properly and optimally made, we can save the file with such settings using **Write** button (like saving any PC file). Later, we can simply invite/**Read** one of such files (for a specific load) and AMMM generator will start operating as previously memorized. We are giving names to such files in the following format: **filename.tune**.

SCANNING TAB

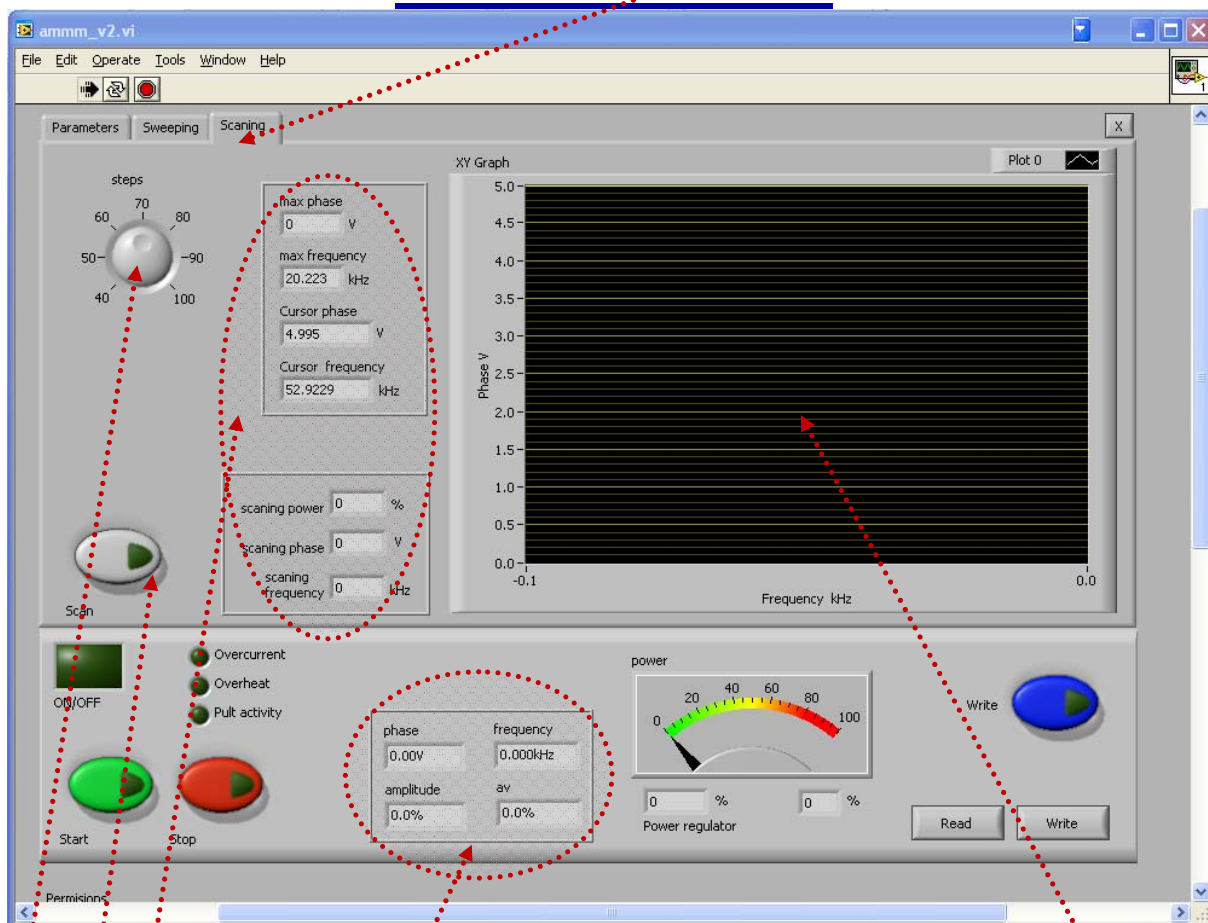

Principal software user-interface for controlling AMMM generators: Third TAB

Steps: Number of measured scanning points (max. 100).

Numerical indicators: All numerically visible values correspond to what we see on the right side screen.

Max. phase: Extreme, measured phase (upper phase value).

Max. frequency: This is the frequency which corresponds to maximal phase value (in reality this is parallel resonant frequency).

Cursors: Can be visualized and moved/dragged by mouse on the right side, scanning screen.

Scan: By pressing this button, phase-frequency scanning is activated. **When performing low power scanning (using our LabView software), in order to find or estimate optimal frequency range of certain transducer, compensating capacitance should be set on minimum (= 5 nF).**

Diagnostic parameters related to automatic phase and amplitude regulation.

OPTIMAL GENERATOR SETTINGS

1. Whatever we do with different generator settings, the answer if this is beneficial for ultrasonic operating regime is the **output power level** that **should be maximized with every particular setting** (watch analog power level meter).
2. The second important criteria is that **ultrasonic load** would **operate very smoothly**, without producing sharp, strange, cracking, whistling, clipping and/or low frequency noise or similar effects.
3. The most important criterion to be able to say ultrasonic system is operating properly and safely (and that will last very long time) is that **nothing is heating significantly and rapidly**. For instance, ultrasonic transducer, other metal parts, executive resonating tools and load should not dissipate too much heat energy and no one joint should heat. Also ultrasonic generator (box) should not heat. Temperature during operation for all mechanical parts should always be close to room temperature and below 50°C.
4. After certain settings are made (when generator is not operating, or during generator operation, in real time, including additional settings and adjustments made later), every time is necessary to save such settings (regardless if generator is operating or not), if we would like that next time (after switching **OFF the generator and repeating switch ON**) generator would start using last settings. When make SAVE = **Write** (by pressing blue button on the bottom right side of the software user-interface panel) the last settings are stored in the generator for currently operating transducer. If the save button (blue button) is not pressed, nothing is saved in the generator, even if adjustments are made during tests (when generator operates). The same procedure should be repeated for every new (different) transducer.

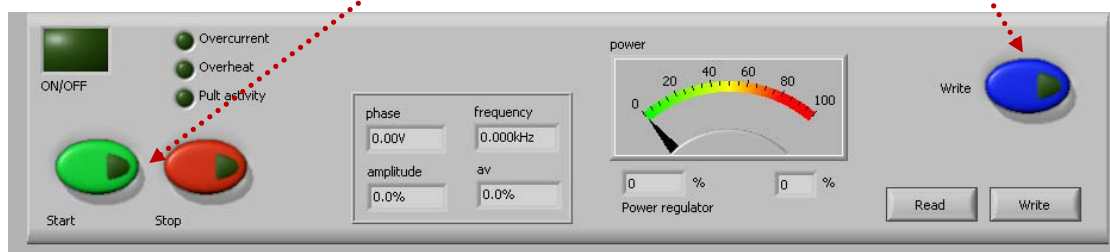

After every power-up it is absolutely necessary to test and find new operating frequency of transducer/s. Why? Let's imagine that generator and transducer are operating for long time under some conditions which are related to: ambience temperature, temperature of piezoceramics, temperature of sonotrode... Such conditions are defining operating frequency of ultrasonic system, which could vary/deviate until 1 kHz compared to initially tested frequency (when transducer was on a standard room, temperature). If the generator shuts-down (for some reason) and after certain time again powers-up (when temperature of critical components will naturally change), the applied automatics

(PLC) which is controlling ultrasonic generator should test again all transducers (all older program parameters are still in the memory of the generator, but new situation related to temperature-dependent acoustic properties is no more the same).

- After all initial settings are made (using a PC and supplied Lab View software), Ultrasonic Generator can be activated, and it will start driving ultrasonic converter by pressing green **Start** button (which is on the software front panel; -lower left corner on all three TABs). Do not start the generator until all initial settings are verified and sett to safe (low power and low risk) positions after the **safe-operating ultrasonic load scanning**.

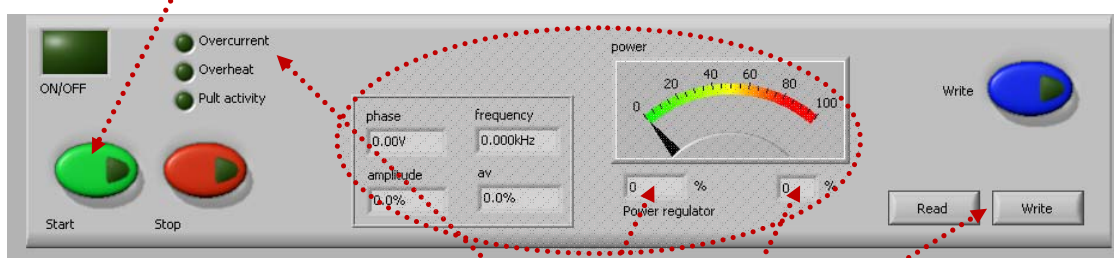

- Now ultrasonic power output can be switched **ON (Start)**. In case if ultrasonic transducer (meaning complete ultrasonic load) is overloading the AMMM generator, generator will stop operating and show **ERROR** message (overcurrent, overheat...). Red color LED on the generator box (front panel) will light, and one of visual indications (either **Overcurrent** or **Overheat**) on the LabVIEW user-interface (lower left side) will be activated. Reduce the amplitude, readjust operating frequency, find new setting (slightly different compared to what was before), and repeat the process until restarting the generator.
- Read – Write options:** After all settings are properly and optimally made, we can save the file with such settings using **Write** button (like saving any PC file). We are giving to such files any name/s we like with **“.tune”** ending. Later, we can simply invite/**Read** one of such files (for a specific load) and AMMM generator will start operating as previously memorized (taking settings data from a specific **.tune** file).
- Power, Power regulator, Phase, Frequency, amplitude and “av”**

Power: Visual (analog) indication of the power level.

Power regulator: **First field** (=) actually regulated power which corresponds to the PWM duty cycle; **Second field** (=) Numerical duplicate of the analog power indicator. Non-editable fields: only indicators.

FRONT PANEL, MANUAL SETTINGS & REGULATIONS

After all optimal settings are found and memorized using LabVIEW software (ammm.exe) we can disconnect RS485-USB controls (stop using PC controls) and continue using only manual settings and controls from the generator front panel (LCD + Rotary encoder). Such manual controls have only 5 options which are 100% identical to 5 of LabVIEW software controls. Other settings (which are not appearing on LCD) are anyway memorized and used during generator operation, but not available for manual modifications and controls.

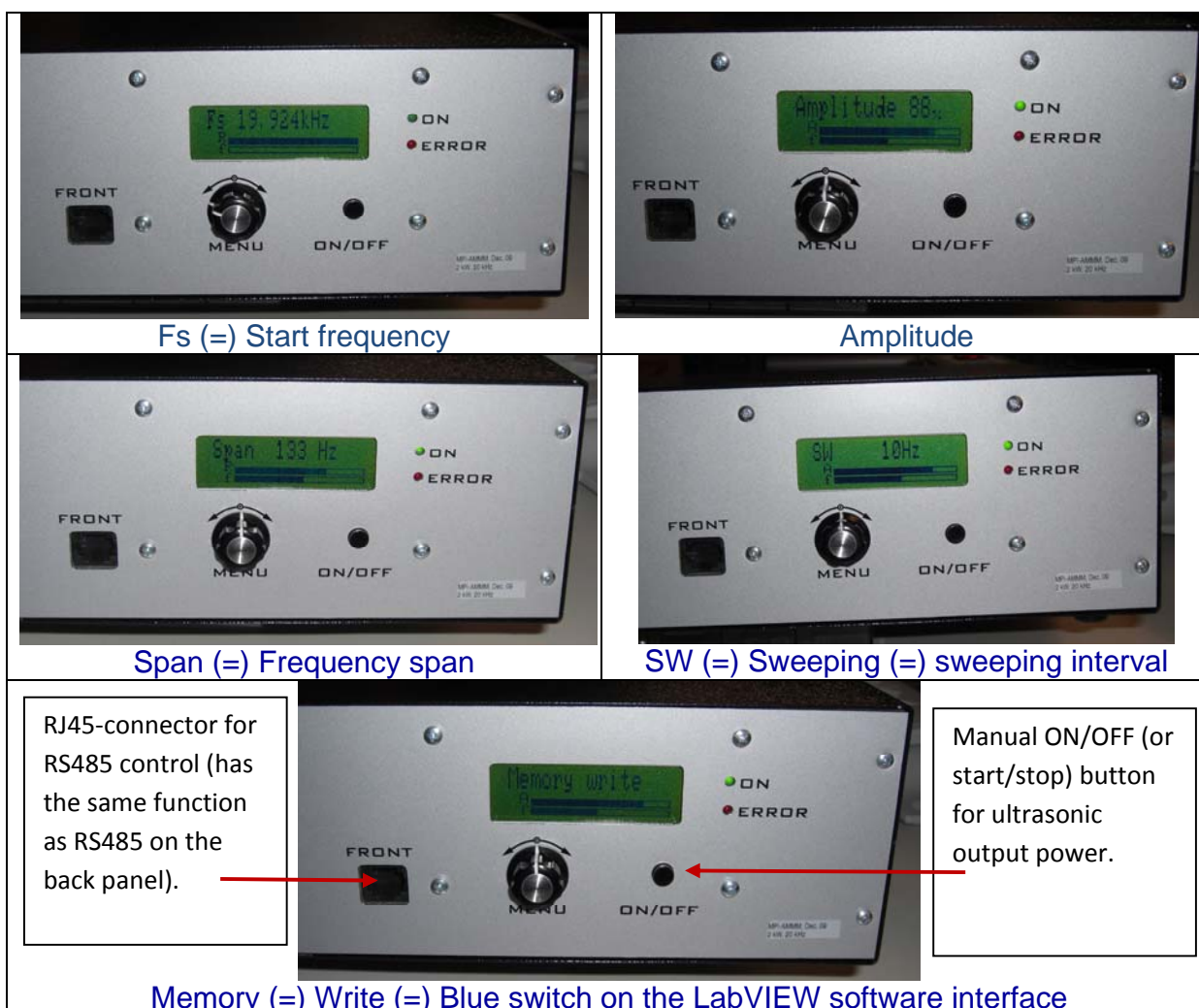

Changing the Menu options (on LCD) can be realized by pressing the Menu knob. Changing actual, numerical values (on LCD) can be realized by rotating the Menu knob (in the middle). It is always better, safer and more comfortable to make such modifications and setting using LabVIEW user-interface software.

AMMM generators can also be controlled using a PLC, or analog signals.

In some of customized AMMM generators we could find either 15-pin or 25-pin Canon (Sub-D) connectors for RS485 interface (usually on the back plate). All pins from 1 to 15 on 15-pin connector are identical to pins from 1 to 15 on 25-pin connector.

On the front panel of AMMM generators there is another RJ45 connector which is also used for RS485 communications between generator and PC (see below).

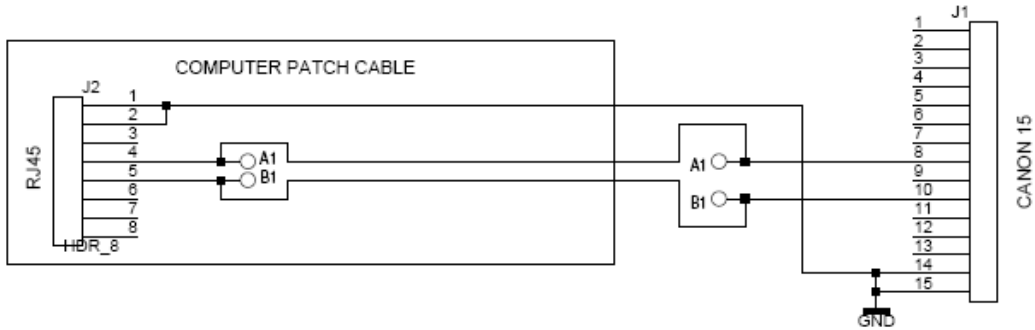

CONNECTORS OF RS485 - USB ADAPTER

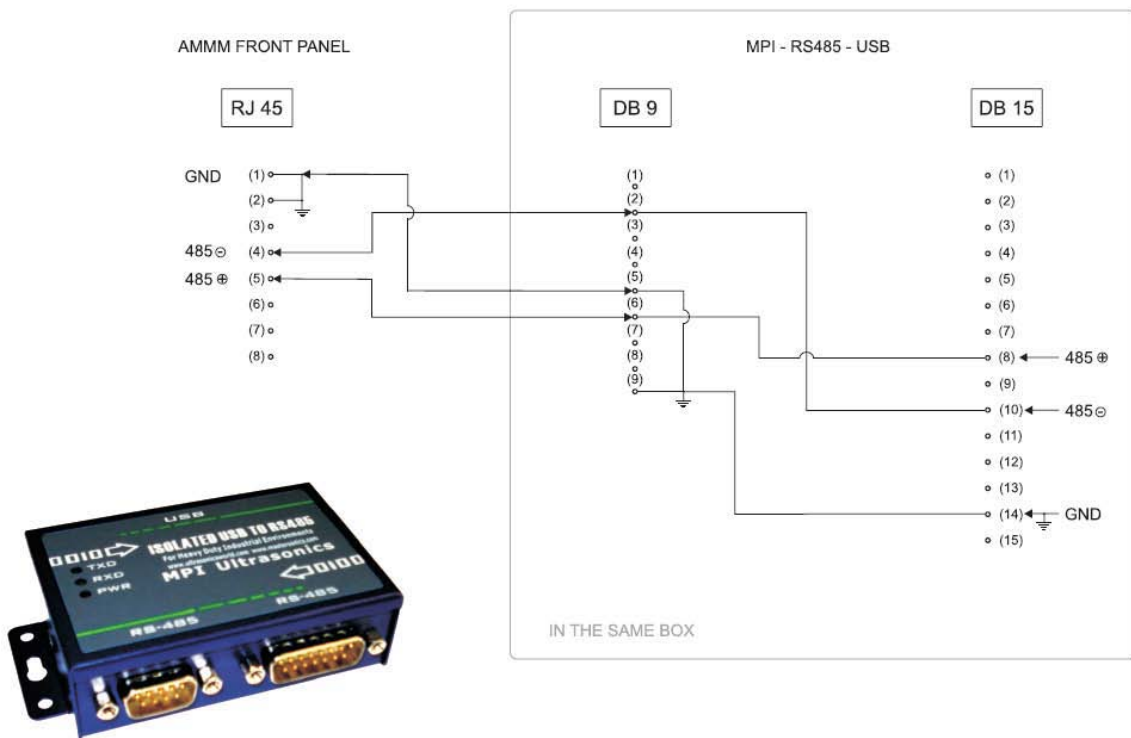

ADDRESSING & NETWORKING

We can also apply (only as an option; -non standard version) additional 25 pin connector for (external) manual, switchable addressing of different converters and sonotrodes (with in advance memorized settings), as for example:

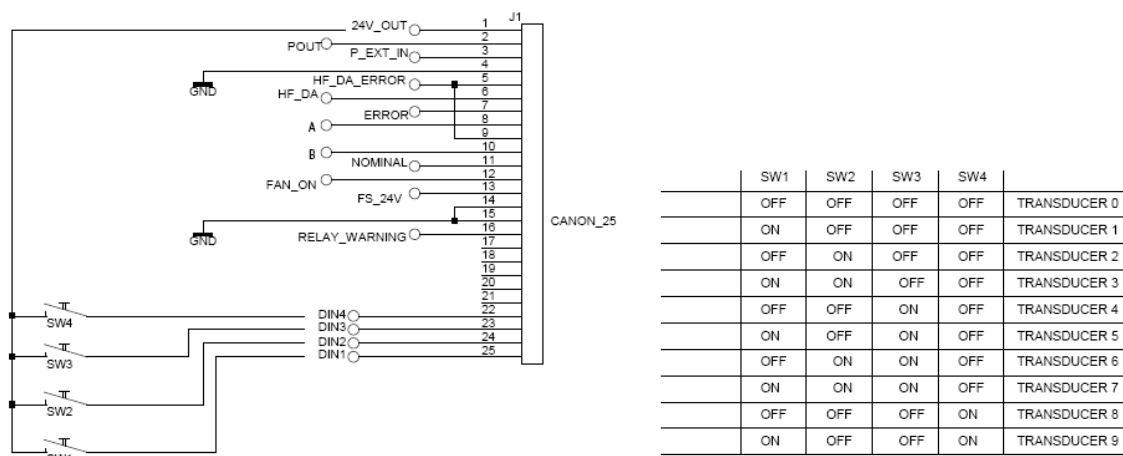

Generators have network function/s but all of them until now are on the same address - 06. -02 address is reserved for LabView software. -All other addresses are free for use. To set the new address of AMMM generator will be possible (allowed):

-from LCD panel

-And/or from LabView software (ammm.exe).

-The address is on the LCD - like parameter. -Every new generator is working on address 6 and could be changed (from LCD) to every upper address from 7 to 30.



-In case of network application/s of many generators, all units should be connected to the same ground.
-Otherwise galvanically (optically) isolated rs485 converters are needed... (also supplied by us).

-The address is available to be changed only from the LCD. Our Lab View software is communicating with generator only when generator is on LCD address "6". When different address is selected, i.e. "12" you need to change it to "6" to be able to connect generator with Lab View, and later to turn it back to "12" (from LCD) and write it in the memory of the generator (from LCD).

OPERATING MODES OF AMMM ULTRASONIC GENERATORS

- A) AMMM generators can operate in the **“FORCED MODE”** (arbitrarily programmable driving of ultrasonic transducers, with different frequency modulations, without single resonant frequency tracking; -when ultrasonic loads have very complex, multi-frequency, wideband Impedance characteristics and when it is necessary to set **Span** value on “0” (=) zero, meaning there is no resonant regime tracking; -no software scanning), and
- B) **“AMPLITUDE-POWER” TRACKING MODE** can be applied when ultrasonic load is composed of big number of ultrasonic transducers operating in parallel connection (such as ultrasonic cleaning baths and similar multi-transducer sonochemical reactors), or when geometry and shape of ultrasonic load is very complex. This is **another kind of forced mode**. In such cases a phase difference between load current and load voltage is not significant or not visible (or permanently fluctuating and load has very complex, multi-resonant impedance characteristic/s). This kind of **“AMPLITUDE-POWER”** level control is realized by varying the actual operating frequency from a minimal starting frequency in the window of selected frequency **“Span”**, on the way to dynamically maintain the set value of **Amplitude and associated maximal power or DC input current** (without applying LabVIEW software scanning), while phase is set to 0 (zero).
- C) In the **“FREQUENCY-PHASE” RESONANT OPERATING MODE** when ultrasonic loads are well tuned to operate on a single, fixed, narrow-banded resonant frequency (select: **continuous** frequency mode), like welding and cutting converters, tuned-probe liquids processing converters etc. In this mode, frequency sweeping (of any kind) is not used. In order to find optimal operating frequency range (**Span**), it is necessary to apply LabVIEW software scanning (right side of the software screen). **When applying software scanning it is very important that ultrasonic load is operating in air (being not loaded).**
- D) We can also apply **MIXED MODE** which is the combination of **FREQUENCY-PHASE RESONANT OPERATING MODE** and **FORCED MODE** until certain level, as much ultrasonic load is able to accept and still operate smoothly and safely (without excessively generating heat dissipation). Sonotrodes and ultrasonic loads which are specifically designed and well tuned to resonate on a fixed frequency are not easily (or not at all) accepting **MIXED MODE**. In order to use **MIXED MODE**, first make all settings and adjustments as for pure **“FREQUENCY-PHASE” RESONANT TRACKING MODE** and then try to apply (as much as reasonable and possible, depending on ultrasonic load bandwidth) certain level of frequency modulations (such as Sweeping, Smoothing, FSWM...).

PERMISSIONS: Below the user-software-interface are software settings/control functions which can be selectively password-blocked before AMMM generator is delivered to a user (see the following picture).

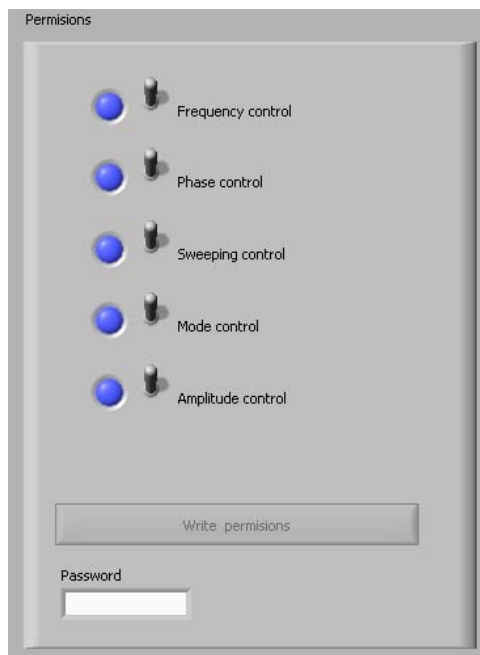

Since all AMMM generators are factory-tested and programmed to drive certain load, in order to prevent that inexperienced user would experiment with unsafe, non-allowed, dangerous, forbidden operating regimes, such settings will be factory-locked (meaning password protected and cannot be used until unblocked). Please respect received instructions.

Before exploring any of OPERATING MODES OF AMMM ULTRASONIC GENERATORS, select proper operating frequency Range, which corresponds to a known operating frequency range of ultrasonic transducer (or load), or enter numerical values manually in the following format: 20-28 kHz (just an example).



Read – Write options: After all settings are properly and optimally made, we can save the file with such settings using **Write** button (like saving any PC file). Later, we can simply invite/**Read** one of such files (for a specific load) and AMMM generator will start operating as previously memorized.

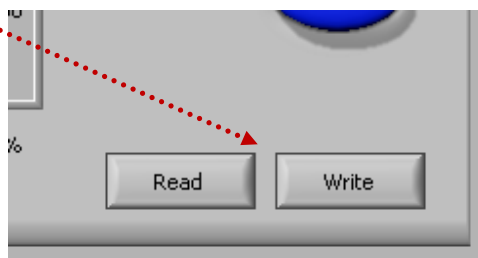

How to change numerical and other setting values for operating frequency and scanning ranges

If we cannot select automatically (by default) proper frequency **Range**, proper **Start frequency**, proper **Span** value and proper scanning range, there is a simple way to do it manually and numerically by direct writing of new, desired values into proper windows.

For instance, if operating frequency **Range** should be something else, compared to what we see on the **Range** window, we can simply click (with a mouse) over the area where frequency interval numbers should appear and type/write on the same way (same format) new frequency interval, like on the picture below:

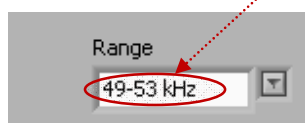

If we would like to change **Start frequency** and **Span** (because by default we do not see desired numbers there), we will again simply click over the last existing numerical position and type new numbers there, like on the pictures below. Old number/s can be simply (manually, by typing) be replaced by new numbers.

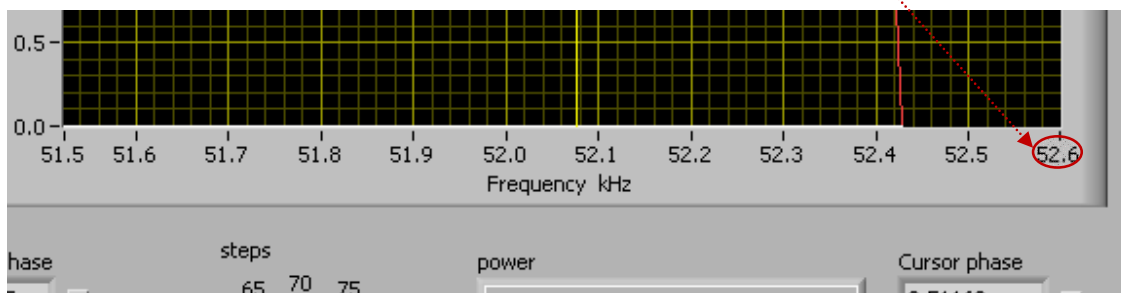
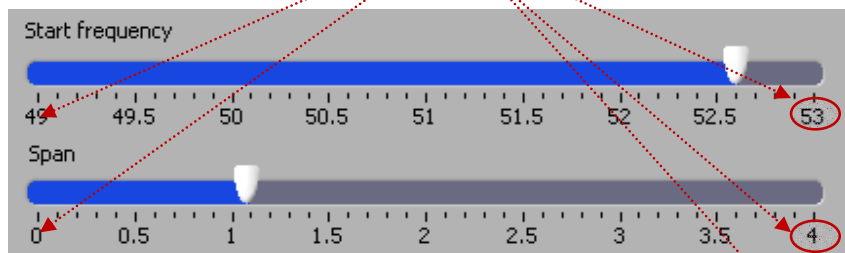

This way we will be able to modify settings and scanning values in order to get most appropriate intervals for specific ultrasonic loads. Of course, certain logic should be respected, since we should not select new numerical values to be outside of the operating limits of AMMM generators.

Literature: [Piezoelectric Transducers Modeling and Characterization \(e-book\)](#)

A) “FORCED MODE” of AMMM Generators (first & second TAB)

To be able to operate certain ultrasonic load in a **FORCED MODE**, set **Span value** to “0” (=) **zero** (meaning there is no resonant regime tracking). Do not use the **Phase** field.

On the picture shown below, with overlapping elliptic areas is marked what is not used, irrelevant, inactive and/or what should not be used when controlling/programming/setting of AMMM generators in a **FORCED MODE**.

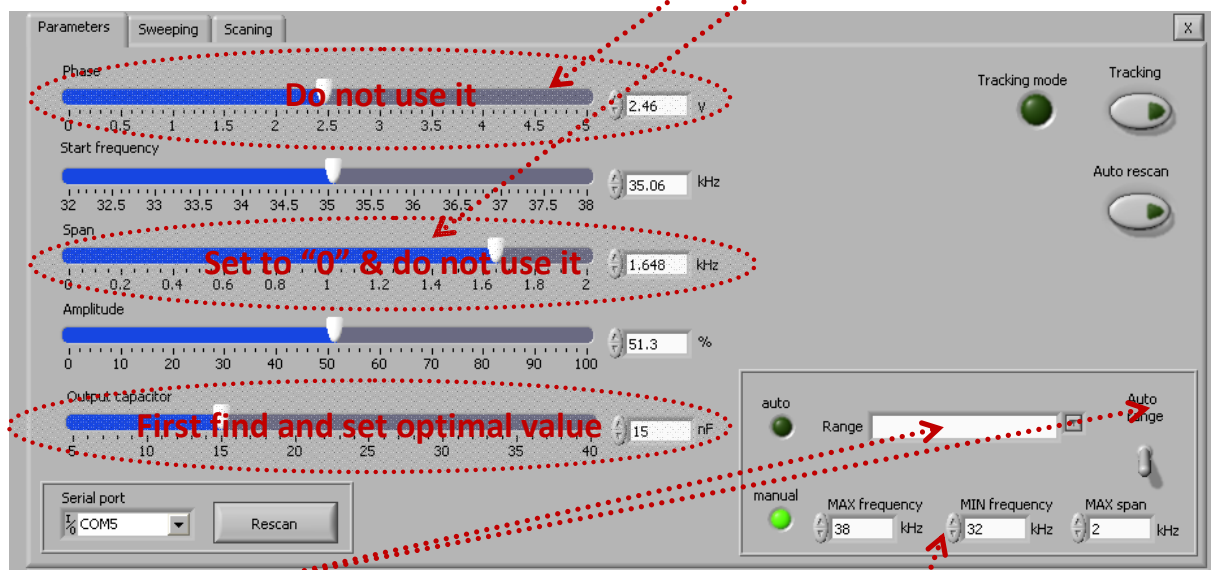

Range: Selectable operating frequency ranges (AMMM ultrasonic generators have many of such frequency ranges). Every ultrasonic transducer and/or ultrasonic load has its acceptable/tolerable and optimal operating frequency range/s (It is usually designed and optimized to operate on certain resonant frequency). Do not select frequency ranges that are not acceptable for ultrasonic transducer and ultrasonic load (something will be damaged). In addition, frequency ranges that are too much different compared to the producer-specified operating frequency range of applied ultrasonic transducer should not be used. In many cases, operating ranges should be selected **manually**, because standard default values are not covering desired operating frequency zone.

FORCED MODE controls and settings: Use everything except zones covered by elliptic surfaces.

Zones covered by elliptic surfaces are **irrelevant, forbidden, not used, fixed or not applicable** (using such controls may damage ultrasonic generator and ultrasonic load).

Mode: Selectable operating frequency modulating modes. Can be selected as **Continuous**, **Periodic** or **AMMM** (AMMM = arbitrary, quasi-periodical, specifically programmed) mode. Linked (or coupled) to **Sweeping and Sweeping frequency** settings. **Continuous mode** should not be used with **FORCED MODE**.

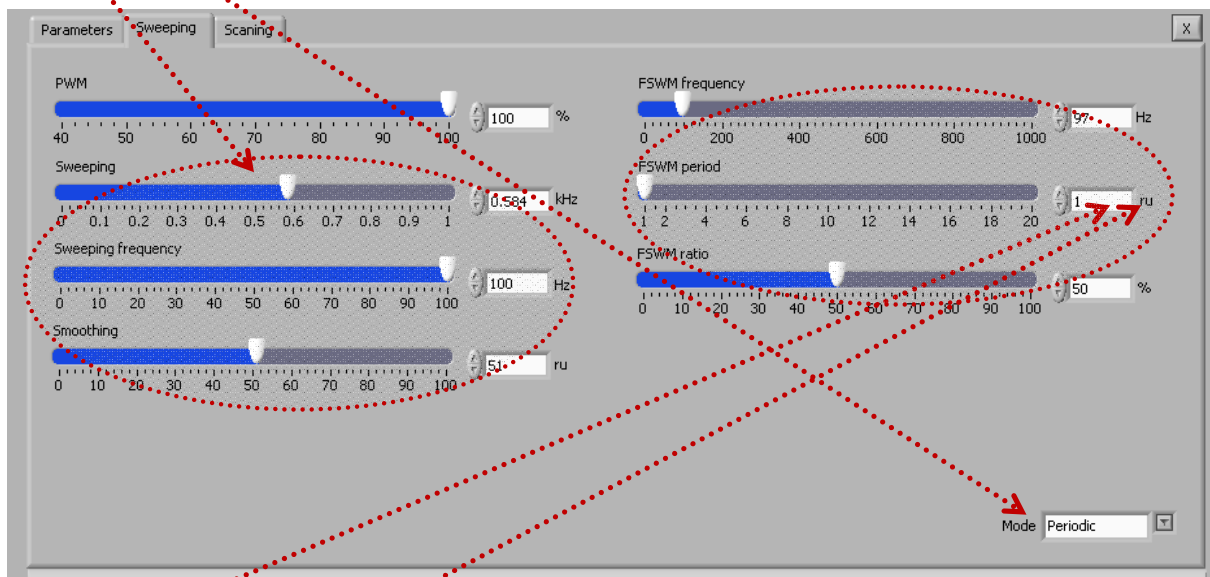

FSWM: Frequency Shift With Modulation (or with PWM). Duty cycle and repetitive frequency shifting or jumping can be regulated. Maximal frequency shifting is 1 kHz. FSWM period is controllable between 0.01 and 20 seconds, what presents the repetition rate which can be regulated until 100 Hz (or much below). FSWM ratio is a duty cycle of the repetition (similar to PWM).

ru (=) relative time units (like seconds)

When operating Low Power (10% to 20%) it is not necessary to use the third TAB scanning functions in the FORCED MODE (but it is still much better to find optimal operating frequency window after low power scanning under loading; - see scanning explanation under C).

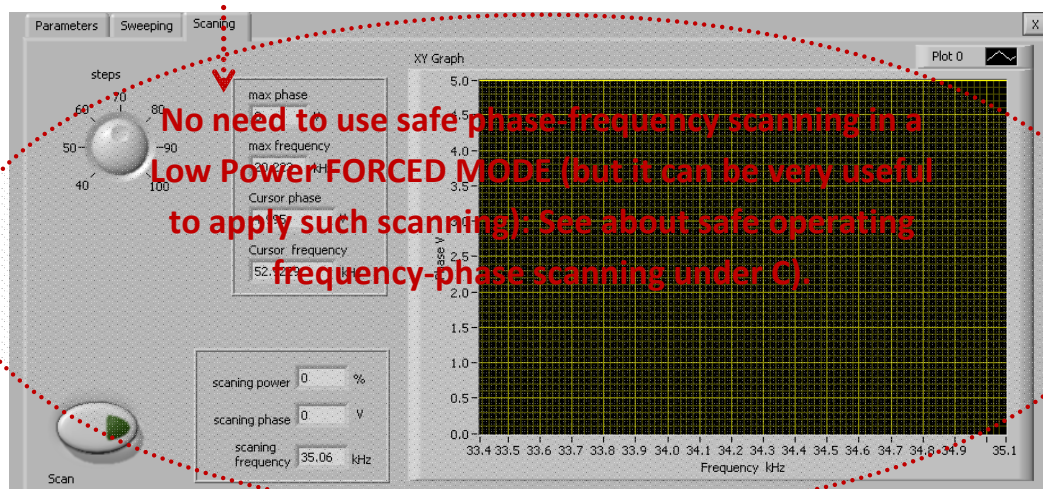

If we are not sure which is the best frequency window for FORCED mode, we should apply SCANNING on a specific way (which will be explained later).

Explanations of FORCED MODE settings & controls

Forced oscillating regimes also have certain preferable, optimal, best-compromising (quasi resonant) operating frequency intervals, and we need to find (experimentally, by manual scanning) the optimal mean frequency for certain of such intervals (which is showing something significant regarding our application).

Phase: Irrelevant, not used in FORCED MODE.

Start frequency: Manually selected, forced mode, central operating frequency.

Span: Set it to zero (0) for **Forced Mode**.

Amplitude: Start testing with lower amplitudes (around 10%). Later, amplitude can be increased.

Sweeping: Equal to interval of frequency sweeping around central operating frequency. Maximal default sweeping interval is 1 kHz. Related to one of selected modes. Can be changed manually (but for most of mechanical systems 1 kHz is already too much).

Sweeping frequency: Sweeping interval repetition rate, or how many times per second sweeping interval is being periodically repeated (or sweeping speed). Maximal value is 100 Hz.

Smoothing: Mathematical, filtering and smoothing function which can prevent execution of very sharp, sudden, discrete frequency modulation. Regulation is realized between 0% and 100% on the rising and falling edges of the frequency-time curves.

PWM: Low frequency, pulse width modulation (or group ON-OFF modulation). Duty cycle between 0% and 100%. Repetition frequency 100Hz. Keep it on 100 for most of cases. In many cases not applicable because mechanical systems are not accepting to operate in such mode.

Operating in a **FORCED MODE** is also a good learning and introductory process to familiarize with AMMM generators operation and to recognize potentially well operating frequency zones in cases of complex and unknown, multi-resonant ultrasonic loads. Later, after we identify all of potentially well-operating frequency areas, we can apply "**FREQUENCY-PHASE**" **TRACKING MODE** to every of such zones and find out which of them are convenient for automatic regulation and resonant phase-frequency tracking.

Write: Saving after making any settings and/or scanning in the local (internal) memory of the AMMM generator.

Read – Write options: After all settings are properly and optimally made, we can save the file with such settings using **Write** button (like saving any PC file). Later, we can simply invite **Read** one of such files (for a specific load) and AMMM generator will start operating as previously memorized.

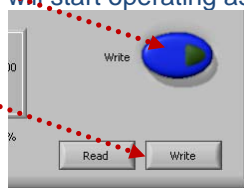

PRACTICAL SHORT RESUME for FORCED MODE:

First TAB settings for operating high power, in a FORCED mode after SCANNING

(first modify the values in the second TAB: set periodic mode)

SCANNING under loading conditions can help us to find the best operating frequency window for applying **FORCED** mode. After **SCANNING** (See about safe operating frequency-phase scanning under C), find a safe operating frequency window and apply the following settings:

1. Set **Phase** to: 0 (meaning NO FREQUENCY-PHASE TRACKING = FORCED MODE).
2. Set **Start frequency** = f_{start} = **Central Operating Frequency** in the middle point between $f_{\text{min.}}$ and $f_{\text{max.}}$. Start frequency is becoming forced, actual operating frequency (such operating frequency, for any load, should be in the middle of the safe operating frequency zone, which is between $f_{\text{min.}}$ and $f_{\text{max.}}$).

$$f_{\text{start}} = f_{\text{min.}} + \frac{1}{2}(f_{\text{max.}} - f_{\text{min.}}) = f_{\text{max.}} - \frac{1}{2}(f_{\text{max.}} - f_{\text{min.}})$$
 This frequency can be later additionally adjusted (changed until obtaining maximal operating Amplitude).
3. Set **Span** to 0 (real FORCED mode does not need predefined Span; -span will depend on sweeping parameters which will be defined on the second Tab).
4. Set initial **Amplitude** between 10% and 30% (preferably start with 20%). Do not go higher, since oscillating amplitudes could be too high and mechanical system can be damaged.
5. Keep Output capacitor on proper value (calculate which capacitor corresponds to certain transducer and certain frequency range; -use Excel macro for calculation).
6. Apply Write Blue Button (data memorized inside the generator) every time after new setting is made.

Second TAB: SWEEPING settings for operating high power, in a FORCED MODE

(after SCANNING: **See about safe operating frequency-phase scanning under C)**

1. Select Mode: **Periodic** (the best for Forced mode).
2. Keep **PWM** on 100% (later for degassing and other technological purposes PWM can be reduced until 80% or lower... carefully).
3. Select initial **Sweeping** (interval) to be $\frac{1}{2}(f_{\max.} - f_{\min.})$ **KHz**... Do not go higher because mechanical system is maybe not able to follow... oscillating parts are heating and under stress. Can be regulated (later) from 0 to $(f_{\max.} - f_{\min.})$ **KHz**.
4. Select Initial **Sweeping frequency** (= speed of frequency sweeping, or repetition rate of frequency sweeping) between 50 and 100. If selected on 100 Hz, we will obtain better volumetric distribution of acoustic waves and uniform cavitations in cases of liquids processing. Do not select higher than 100Hz (most of mechanical systems are not able to follow).
5. **Smoothing**: keep on 0 (very low values are generally better than higher values).
6. **FSWM**: Keep on 20 Hz or less (higher values could damage mechanical system).
7. **FSWM period**: 0 (keep always on minimum). This is corresponding to 100 Hz repetition rate of **FSWM**.
8. **FSWM ratio**: Keep initially on 50% (good compromise for most of ultrasonic loads, known from testing...).
9. Apply Write Blue Button (data memorized inside the generator) every time after new setting is made.

B) “AMPLITUDE-POWER” FORCED TRACKING MODE (first & second TAB)

To be able to operate certain ultrasonic load in “**AMPLITUDE-POWER**” TRACKING MODE, “Tracking” button is pressed (activated) and/or “Phase” is set to “0”. This kind of operating regime regulation can be applied when ultrasonic load is composed of big number of ultrasonic transducers operating in parallel connection (such as **ultrasonic cleaning baths** and similar multi-transducer sonochemical reactors), or when geometry and shape of ultrasonic load is very complex. In such cases, a phase difference between load current and load voltage is not significant or not visible (or, permanently fluctuating and load has very complex, multi-resonant impedance characteristic/s). In such **Tracking mode** the generator is regulating the **power which numerically corresponds to the same amplitude** (i.e. when 60% amplitude is set, maximal regulated average power will also be 60% of nominal power of the generator). This kind of **AMPLITUDE-POWER** level control is internally realized by increasing the actual operating frequency from a minimal starting frequency in the window of selected frequency “Span”, on the way to dynamically maintain the set value of **Power**. **Amplitude** corresponds to an average, mechanical peak-to-peak oscillating interval of the transducer/s (expressed in relative percentage units from 0% to 100%). Software **Scanning** is not used in this mode (third TAB), but it can be used on the same way as explained for FORCED mode under A).

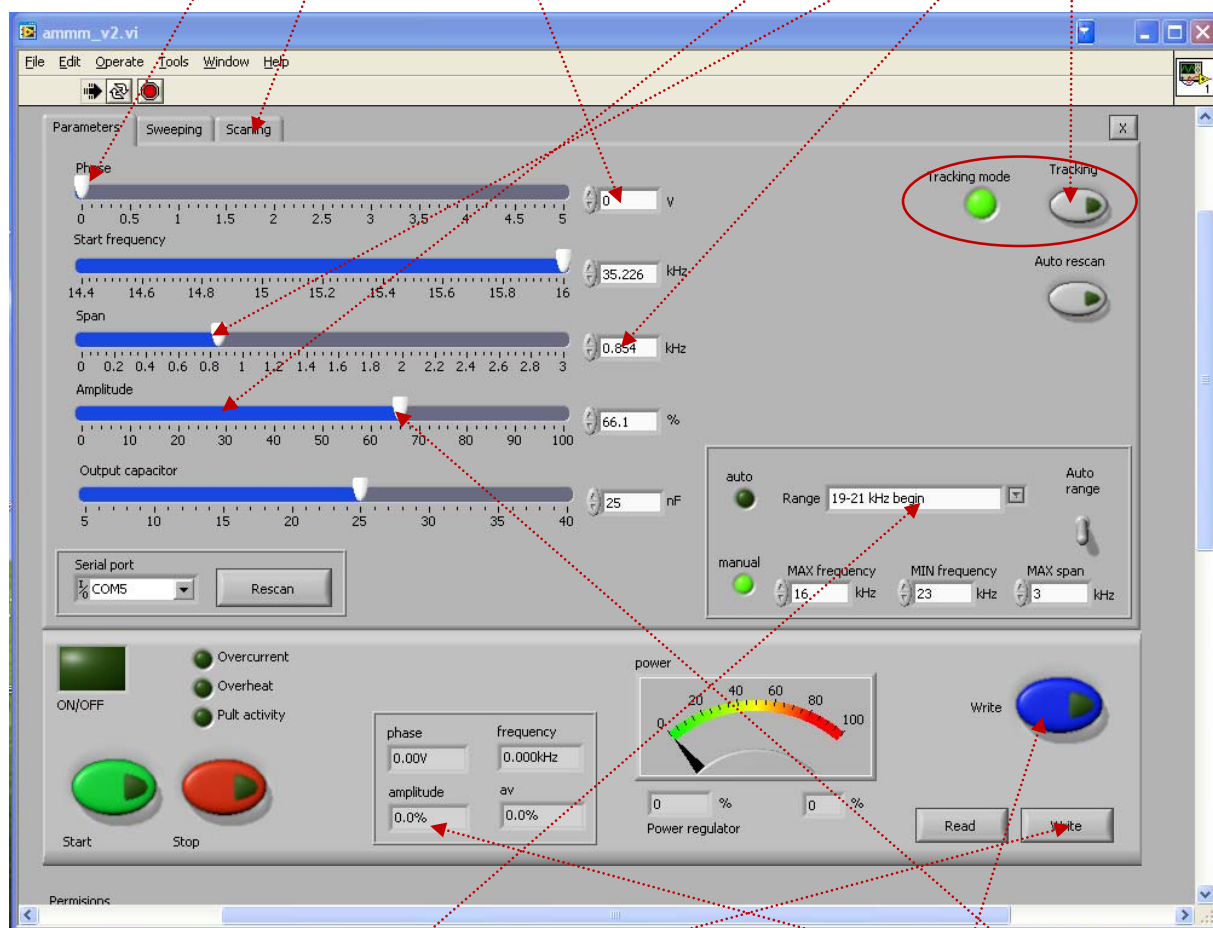

“**Tracking**” button is pressed (activated) and/or “**Phase**” is set to “0”. Everything else can be adjusted until optimal operating conditions are reached. Select proper frequency **Span**, which is producing expected **Amplitude**. Select proper frequency **Range**. Select proper capacitive matching (first TAB). **Save/Write** inside of the generator memory. **Save/Write** settings as any computer file. [See about safe operating frequency-phase scanning under C\).](#)

C) “FREQUENCY-PHASE” RESONANT OPERATING MODE (first & third TAB)

are all resonant modes when ultrasonic loads are well tuned to operate on a single, fixed, narrow-banded resonant frequency (continuous frequency mode), like welding converters and tuned-probe liquids processing converters). In this mode, **frequency sweeping (of any kind) is not used (second TAB)**. Most of ultrasonic piezoelectric converters (and generators) are operating in a fixed frequency mode, either on parallel, f-p, or series f-s, resonant frequency. AMMM generators in a **“frequency-phase” operating mode** are operating between series and parallel resonant frequency (usually closer to parallel resonant frequency), this way combining advantages of series and parallel resonance regimes while keeping output oscillating, **mechanical amplitude constant** (on a selected level).

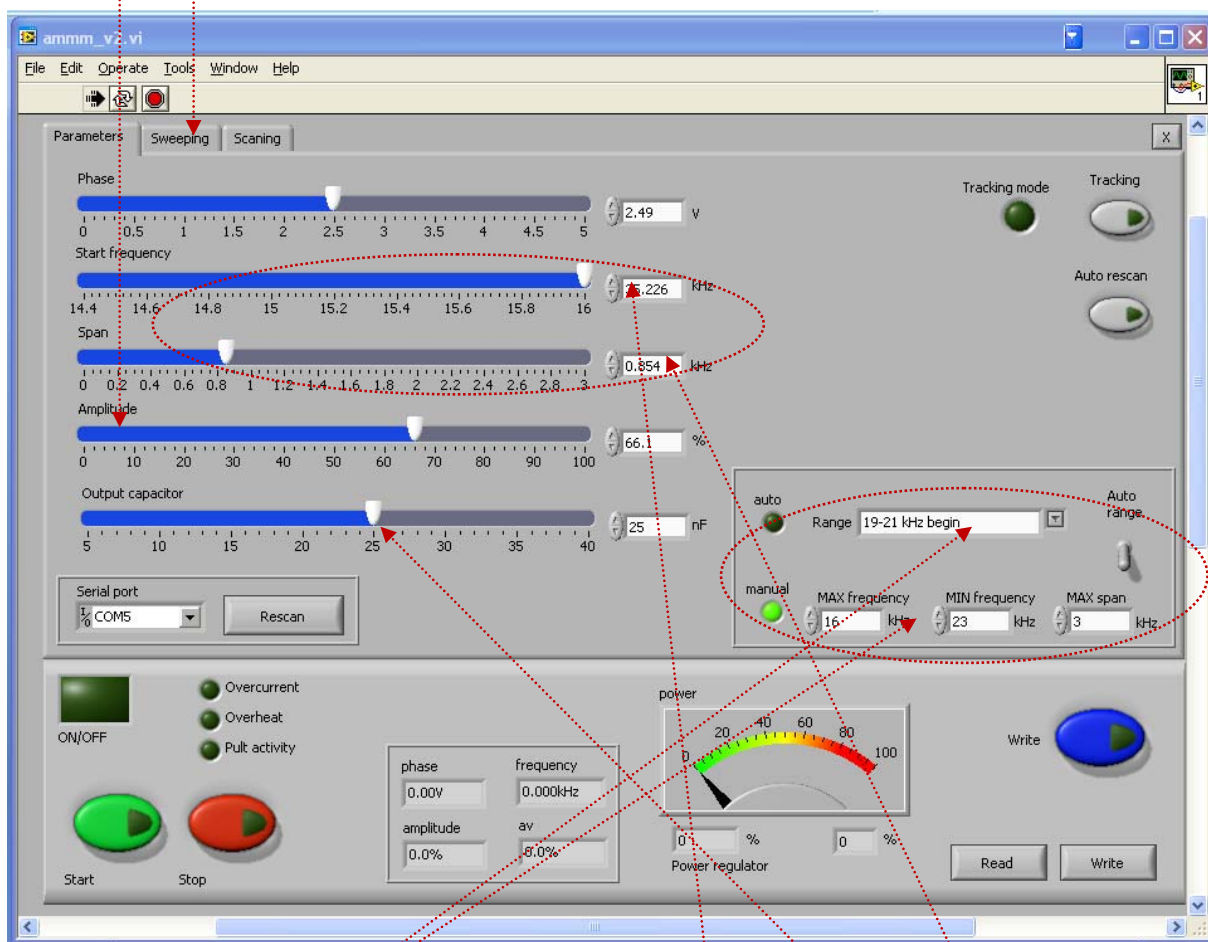

Before analyzing/scanning and using **frequency-phase operating mode**, select proper operating **frequency range**, which corresponds to a known operating frequency range of ultrasonic transducer (or load)? Also set **Output capacitor to 5 nF**, before making any scanning and testing. Select initial, upper **Start frequency** and **frequency Span** to cover little

bit larger frequency zone around series and parallel resonant frequency of the applied ultrasonic load.

Frequency sweeping (of any kind) is not used (second TAB) in “Frequency-Phase” operating mode.

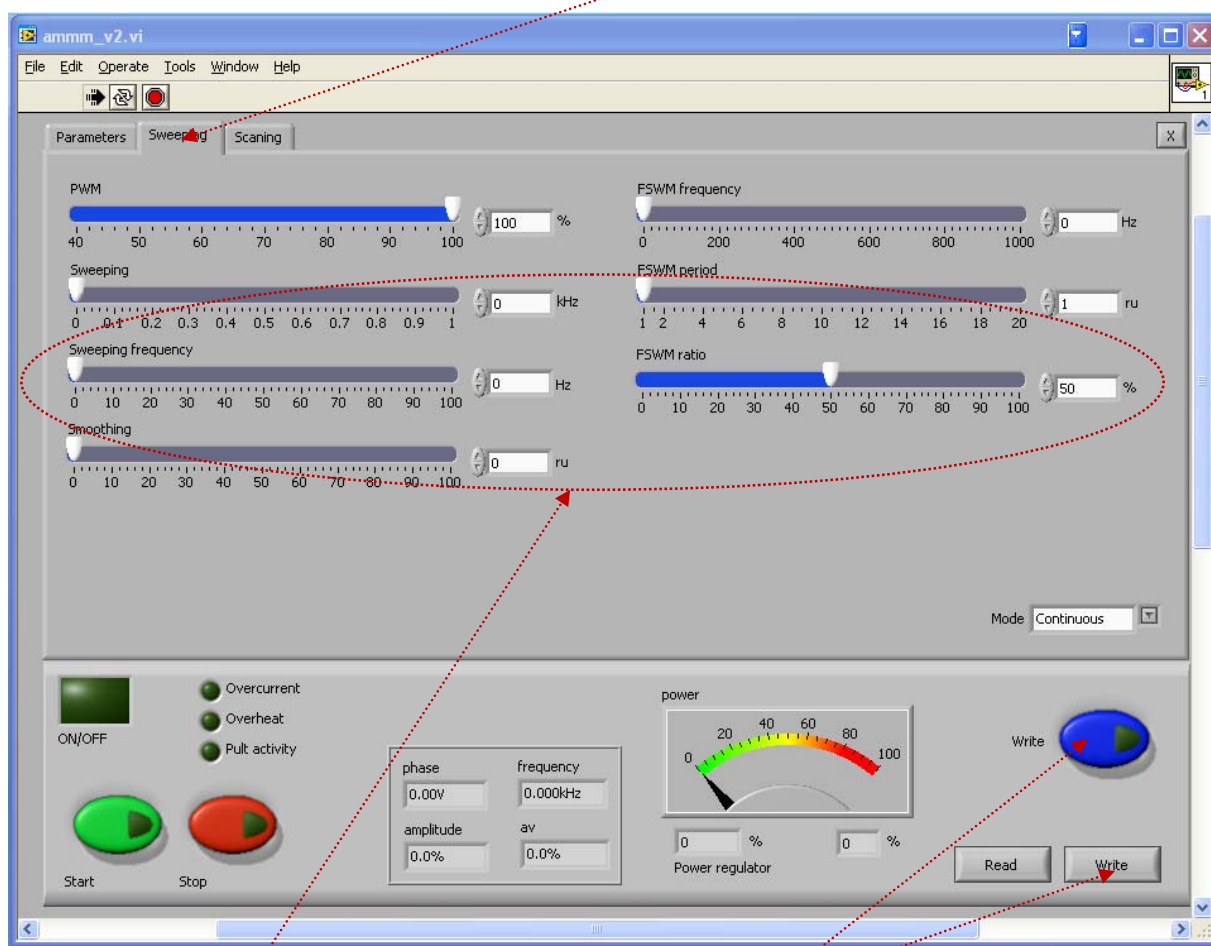

Elliptically encircled setting zones (of LabVIEW software ammm.exe) are not used in a resonant “**frequency-phase**” tracking mode. **Save/Write** inside of the generator memory (last operating or last settings situation). **Save/Write** settings as for any computer file.

Scanning (=) "Frequency-Phase" measurements TAB

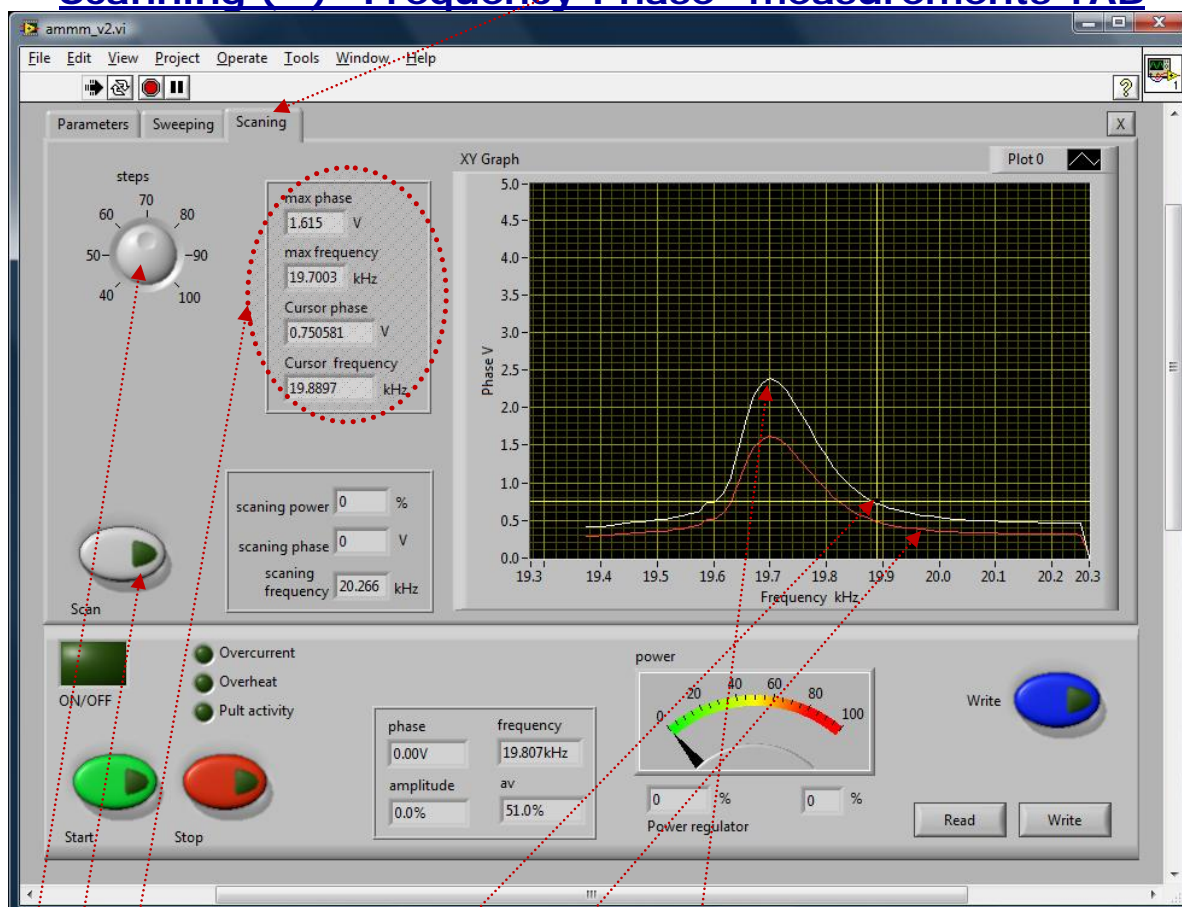

Steps: Number of measured or scanning points (min. 40, max. 100).

Numerical indicators: All numerically visible values correspond to what we see on the **right side screen**.

Max. effective phase: Extreme, measured phase (upper phase value: **white color curve**).

Real Phase (=) red color curve

Max. frequency: This is the frequency which corresponds to **Max. effective phase** value (in reality this frequency is slightly lower than parallel resonant frequency).

Cursors (yellow horizontal and vertical lines): Can be visualized and moved/dragged by mouse on the **right side, scanning screen**.

Scan: By pressing this button, phase-frequency scanning is activated. In order to find optimal operating frequency range (Span), it is necessary to apply LabVIEW software scanning (right side of the software screen).

Effective, corrected Phase curve: (=) white color curve (=) Combined value of Real Phase & output Load Current; it is always higher and wider than **Real Phase** (used for phase-frequency regulation).

Low Power Scanning or “Frequency-Phase” measuring mode is the safe-operating, low-power frequency scanning of ultrasonic load (Ultrasonic converter + booster + sonotrode + etc.), where the scanning display would visualize the phase difference between a load current and load voltage versus frequency (**red color curve**), and Effective, corrected Phase curve (**white color curve**). Such frequency scanning is realized using the LabView software (**ammm.exe**) supplied with ultrasonic generator). In order to make scanning, personal computer with installed Lab View software should be connected to ultrasonic generator through RS485 interface. **When applying software scanning (or frequency-phase tracking) it is recommendable to make scanning when ultrasonic load is operating in air (being not loaded), and later to make the same scanning when transducer is loaded (and to compare results, which should be mutually similar).**

When performing low power scanning (using our LabView software), in order to find or estimate optimal frequency range of certain transducer, compensating capacitance should be set on minimum (= 5 nF). Later, in real high power operating regime, compensating capacitance should be selected properly (increased until optimal operating conditions).

Initially (first safe operating, low power frequency scanning) should be selected to cover only the expected operating frequency range of ultrasonic system. For instance, if we know the series and parallel resonant frequency of certain transducer (measured by impedance analyzer), selected scanning frequency interval should be little bit wider and overlap both series and parallel resonant frequencies.

In here-described scanning, frequency is smoothly changing towards lower values, starting from f-start (which is higher than parallel resonant frequency) and finalizing scanning at the frequency that is equal to f-start – **Span**. Span is the frequency interval we select as a frequency-capture range (in Lab View Software).

For instance, if ultrasonic system consists of 20 kHz ultrasonic converter + 20 kHz booster + 20 kHz sonotrode (where not all of them are exactly tuned to operate on 20 kHz, or have single operating frequency of 20 kHz), we know that we should expect the resulting, central operating frequency of such system to be somewhere close to 20 kHz. Consequently, we could select the scanning frequency range to be between 20 and 21 kHz (meaning f-start = 21 kHz, and **Span** = 1 kHz). Of course, another relevant example could be to select such frequency scanning between 19.5 kHz and 20.5 kHz (meaning f-start = 20.5 kHz, Span = 1 kHz). Later (during scanning), the Lab View software will search and find real, average operating frequency somewhere inside of the area covered by scanning).

In the next step (next safe-operating frequency scanning) we should select new (shorter) value for Span to cover only the central part of the phase curves (both, red and white color curves). New f-start will be again at the point where the phase curve is minimal (meaning closer to parallel resonance).

This way, we will visualize mentioned part of the phase difference curve on a larger display, and we will be able to estimate the frequency which is in the middle of that frequency interval, and which is approximately equal: f-start – 0.5(**Span**). Later, real AMMM operating frequency regime (under automatic effective phase regulation, found by internally implemented hardware and software) will find its average or effective operating frequency (inside of the new Span interval) and we will be able to perform/set large frequency sweeping around that frequency (in both directions).

See examples of good Span and frequency capture selection on the pictures below:

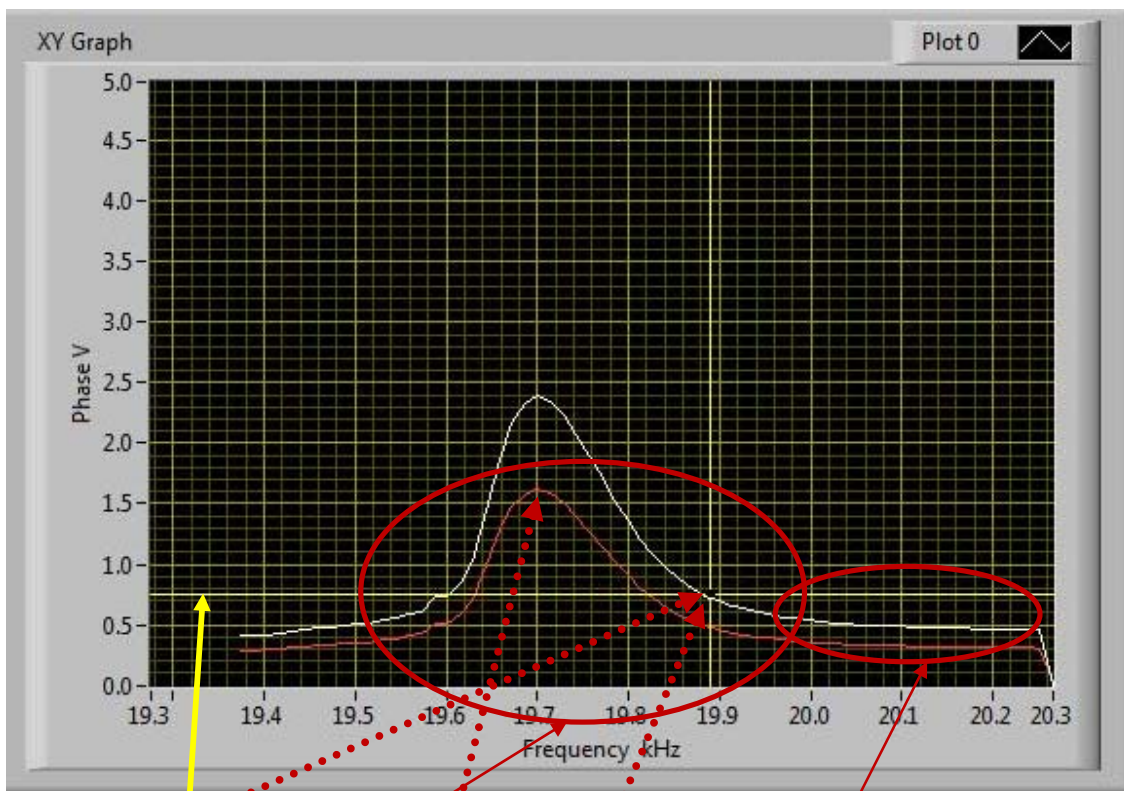

Relevant, most probable operating point, which is good for automatic frequency and phase regulation; on the white color curve).

Real phase curve (red color curve); has only informative meaning to recognize where the well operating frequency interval is). White and red phase curve should be seen on a similar way, together (in any other case).

In this frequency frequency-capture area (here from 19.5 until 20 kHz) converter will be operational and automatically regulated by ultrasonic generator under different dynamic, loading conditions. Series and parallel resonances are inside the encircled area (not visible on this scanning plot, but if measured by Impedance Analyzer, would be here).

This is the most probable and expected phase level (phase set point) that will be regulated by ultrasonic generator (here about 0.75 V). We are intentionally selecting such smooth, linear phase area, since such areas are easy for automatic regulation. Yellow horizontal and vertical lines are manually moveable cursors that are useful for estimating and marking most probable operating phase and frequency (where automatic regulation will be optimal).

In this frequency area we should select the Start frequency: f_{start} . Ultrasonic generator will start operating from selected start frequency and very fast find its optimal resonant frequency that is under automatic regulation, here. If converter is operating in air, this frequency will be very close to its parallel resonant frequency.

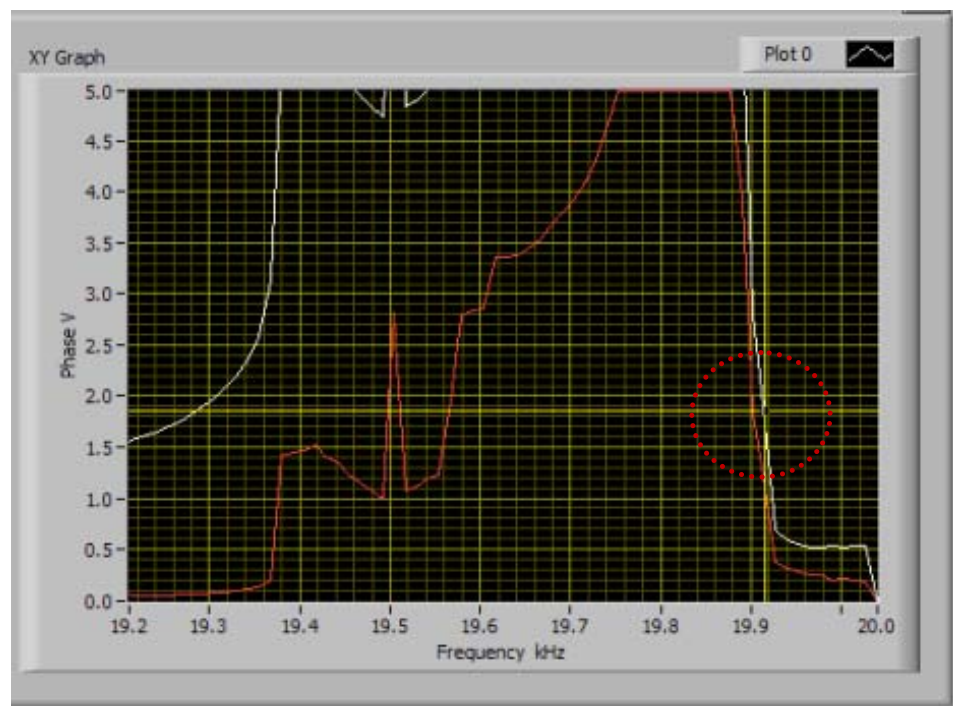
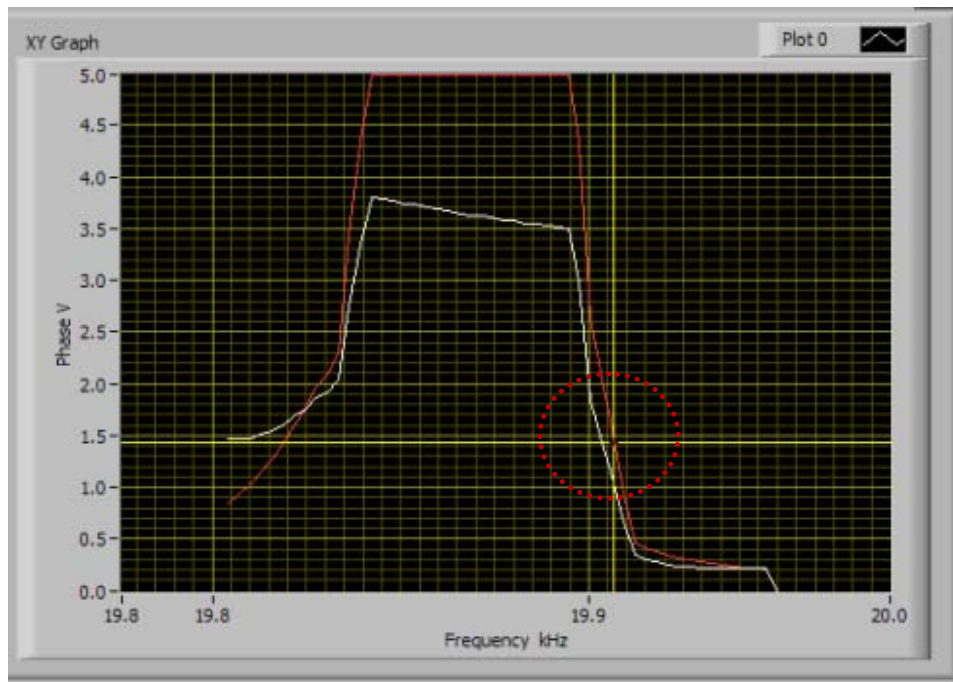

Two examples (different piezoelectric converters) of properly selected phase set point that will be automatically regulated.

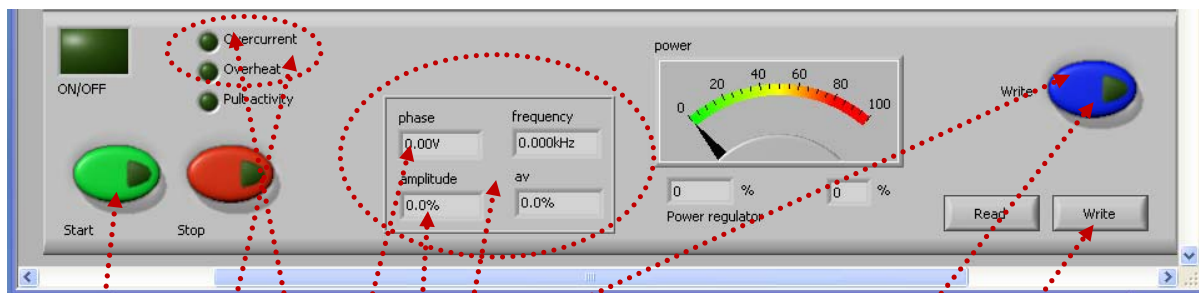

After successfully finalizing scanning (in some cases by repeating scanning and adjusting frequency intervals several times) when optimal operating frequency-capture zone is selected we need to **Write** (memorize) such settings (in the generator internal memory) by pressing the **blue Write button**.

Now it is necessary to set the **optimal (starting) phase value** (which should be automatically regulated) on the First TAB (and press **blue Write button**).

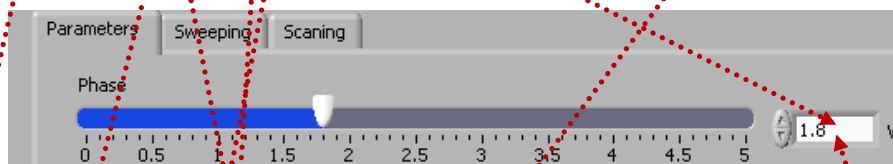

We can test the selected, resonant operating frequency range by pressing **green color Start button**. First time activation of the **Start button** will produce short/fast control scanning of the operating zone of ultrasonic load and compare it with already memorized scanning results that are inside of the generator memory. If results of such short **test scan** are acceptable, **no error message will be generated** and generator can be considered as READY for regular, high power operating regime. We can **Write** computer file which will save all AMMM generator settings. Next time, in case of **overcurrent detection**, if we press the **green Start button**, AMMM generator will start operating in low power TEST operating mode in order to find new resonant operating point; and generator will automatically stop.

Significant diagnostic indicator field (which is not editable), showing automatically regulated operating regime of AMMM generator with parameters that are related to automatic regulation of **effective phase** and **amplitude** (with closed feedback loops regulations).

Effective phase: Detected voltage which corresponds to operating and regulated **effective phase** point (between 0 and 5V; 0V = -90° phase, 5V = Max-phase = $+90^\circ$). Actual operating **effective phase** should be automatically regulated and (in case of properly selected operating regime, and properly made settings) should be almost equal to **setting phase value on the first TAB** meaning that automatic effective phase regulation is operating properly. If not, we need to find new working regime. **Phase set point, start frequency, compensating capacitance and frequency Span can be later slightly changed in real time, during ultrasonic generator operating high power, until we reach desired operating amplitude regulation, while still keeping automatic phase regulation. These are very important and very useful options.**

frequency: Actual operating frequency which corresponds to controlled **effective phase**.

amplitude: This is very particular amplitude regulator, which is starting to regulate amplitude from certain (minimal) threshold point (which is specific for every ultrasonic load). Below that amplitude threshold point there is no automatic amplitude regulation (amplitude is too small to be regulated). Starting from the amplitude threshold AMMM generator is making automatic amplitude regulation (percentage-wise), which should be almost equal to the set point level of **amplitude given on the first TAB settings**. Upper amplitude level that can be reached by automatic regulation is also limited. Example: For certain transducer, we will be able to have smooth, automatic amplitude regulation only between 20% and 70% of the full scale (and **we should never expect that automatic amplitude regulation will operate from 0 to 100%**).

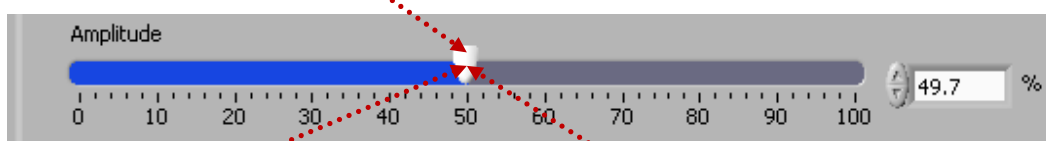

If mechanical (ultrasonic) load starts consuming power that numerically corresponds to the **percentage of the amplitude set point**, generator will start regulating power instead of regulating amplitude, but using the same numerical value **of the amplitude**. Example: If the set point of amplitude is 50%, generator will regulate amplitude on 50% in the power range from 0% to 50%. If consuming power will increase (over 50%), generator will start regulating only the power taking 50% as the nominal generator power or set point for power (and amplitude will automatically decrease, giving priority to the power regulation). If the consumed power will drop below 50%, amplitude regulation will automatically become dominant regulating process, and amplitude will be regulated on 50%.

Power regulator (%): Is the actuator value of the automatic (closed loop regulator) **for amplitude and/or power**. This is real time indicator. Ideal situation is for power regulator is to be close to the set point of amplitude (and/or power).

av (%): Is the actuator value of the automatic (closed loop regulator) for **effective phase**. This is real time indicator. Ideal situation is that **av** is close to 50%, meaning to be somewhere below or around the **middle area of Span**.

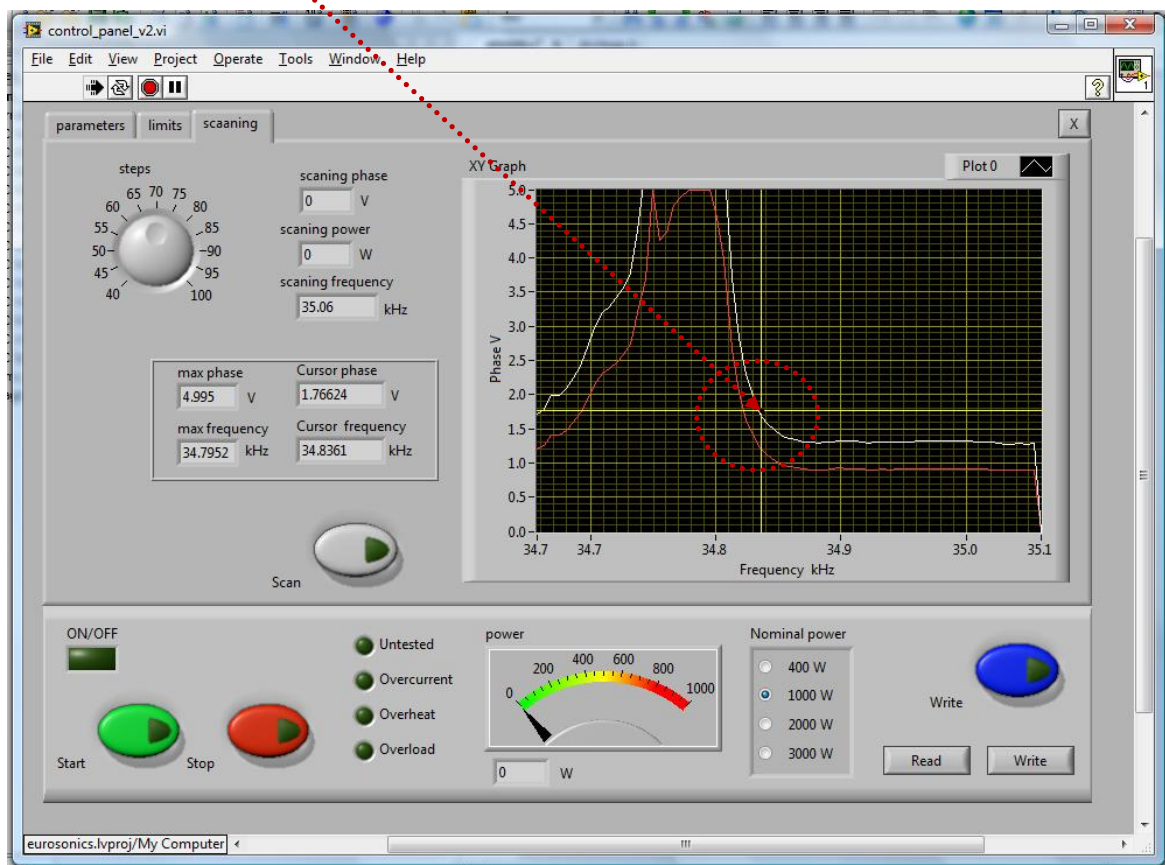

If "av" is showing 0 (zero value) this means that starting frequency (f-start) is selected too low. Change f-start and place it slightly higher compared to the value selected before.

If "av" is closer to maximal values, either starting frequency is selected too high, or "Span" value is not large enough. Change f-start and **Span** value, until getting **av** between 30% and 50%.

Later, after scanning and proper operating regime is found (when proper f-start is found); - sweeping parameters and power level can be readjusted (if necessary). **Phase set point, start frequency, compensating capacitance and frequency Span can be later slightly changed in real time, during ultrasonic generator operating high power, until we reach desired operating amplitude regulation, while still keeping automatic phase regulation. These are very important and very useful options.**

The generator has an automatic "frequency tuning" inside the frequency capture range (see the explanation that follows). The **frequency capture range** can be set by "Span" parameter from 0 to 1 kHz (below the start frequency, towards lower frequencies: f-capture = f-start - Span). If

we set $\text{Span} = 0$, generator will not search for optimal operating frequency between Series and Parallel resonances (and generator will operate in a relatively fixed and **forced**, non-resonant, not automatically controlled oscillating regime, with fixed and forced frequency sweeping, regardless of impedance characteristics and natural resonant frequencies). In such situations, we can set start frequency anywhere we like (no automatic regulation).

The operating resonant frequency of ultrasonic system must be found in advance (before operating the system full power), performing initial low power scan testing with the generator LabVIEW software. This frequency will be found somewhere below the frequency where scanned generator current is maximal, and where the scanned phase function is smoothly rising from its minimal value towards its maximum, when in the same time, the frequency is going towards lower frequencies). The frequency area which is covered (by this type of regulation) depends on the device type (it is impedance-characteristic dependent: $f\text{-capture} = f\text{-start} - \text{Span}$).

Frequency-capture range should be found when generator is performing the safe operating, low-power frequency scanning of ultrasonic load (Ultrasonic converter + booster + sonotrode + sonotrode-tool). Here, the scanning display (LabVIEW software) would visualize the phase difference between a load current and load voltage versus frequency (red color curve), and effective, corrected phase curve (white color curve), which is the combination of real phase and output, load current. Such low-power frequency scanning is realized using the LabVIEW software supplied with ultrasonic generator). In order to make scanning, personal computer with installed Lab View software should be connected to ultrasonic generator trough RS485 interface as explained before.

Initially (first safe-operating, low-power frequency scanning) should be selected to cover only the expected operating frequency range of ultrasonic system (**Span**).

Initial Start frequency and **Span** can be adjusted on the left side of the software screen (see the picture below).

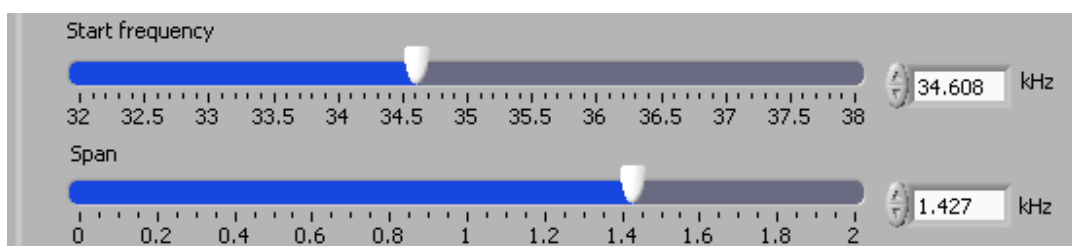

In here-described scanning, frequency is smoothly changing towards lower values, starting from $f\text{-start}$ and finalizing scanning at the frequency that is equal to $f\text{-start} - \text{Span}$. **Span** is the frequency interval we select as a frequency-capture range (in LabVIEW Software).

Later (during scanning), the Lab View software will draw the Phase and Current characteristics (versus frequency) inside of the area covered by scanning (by **Span**).

1. On the lower left side of third scan TAB, there is the **Scan** button, which is activating the safe-operating, low power ultrasonic load scanning (kind of load impedance scanning). Before **Scan** is activated, it is important to select scanning frequency resolution (number of **steps**), which is selectable from 40 to 100. See **Scan** and **steps** positions on the picture, below.

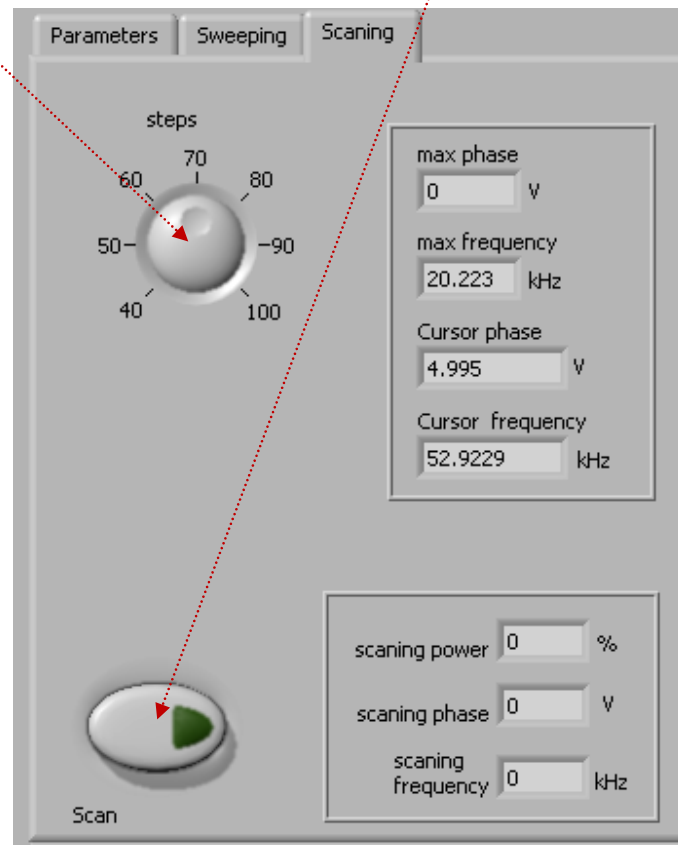

After certain time scanning will stop and on the upper right corner of the user-software interface we will see the plots of scanned real phase (red color curve) and effective, corrected phase (white color curve). The typical scanning screen (in case of well selected operating resonant mode) is presented on the picture below.

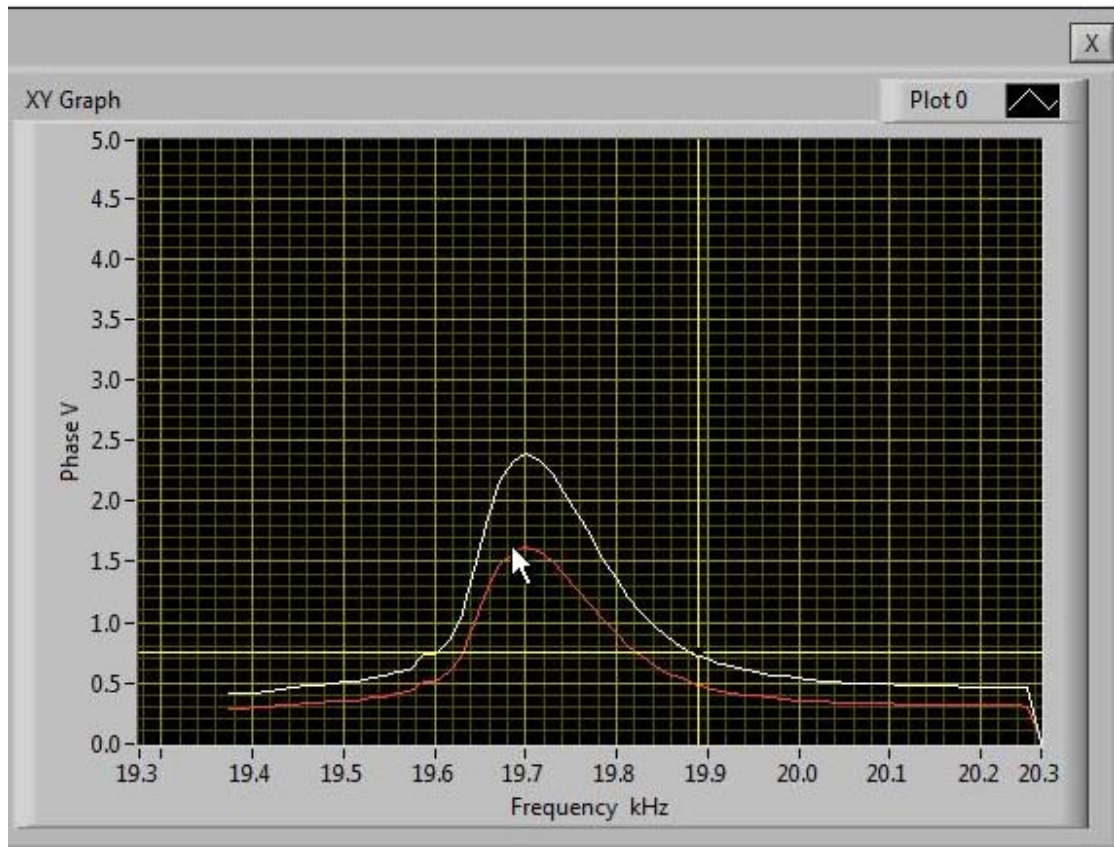

This way, we will visualize (zoom) mentioned part of the phase difference curve on a larger display, and we will be able to estimate the frequency which is in the middle of that frequency interval, and which is approximately equal: $f\text{-start} - 0.5(\text{Span})$. Later, real AMMM operating frequency regime (under automatic regulation found by internally implemented hardware and software) will find its average or central operating frequency (inside of the new **Span** interval) and later we will be able to perform/set even larger frequency sweeping around that frequency (in both directions).

Find proper resonant mode and start frequency $f\text{-start}$ by measuring Impedance-Phase-Frequency characteristics using Lab View software (as already explained). Have in mind that initial resonant frequency characteristics will change after certain time, because of ultrasonic oscillations and involved materials aging and stabilization (stress relief, friction between contact surfaces, thermal aging, operating temperature...). Also, resonant frequencies will be very much operating-temperature dependent (converter and sonotrode could heat during operation). Repeat scanning of phase-frequency and input current characteristics after certain time, or in case of noticing problems during ultrasonic oscillations (maybe resonant characteristics are significantly changed and new generator settings should be applied).

2. Set the “**PHASE**” initial value (first bar) in the range from 0.5 to 3V (ideally and preferably until 2.5 V, because maximal phase comparator DC voltage is 5 V; -see the picture below). Do not start the generator until all initial settings are verified and sett to safe (low power and low risk) positions.

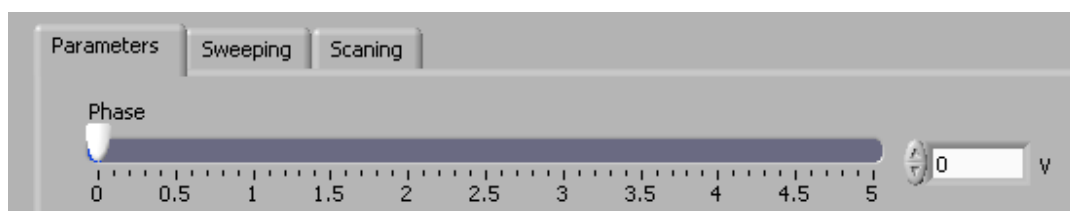

3. After all initial settings are made, Ultrasonic Generator can be activated (from a PC), and it will start driving ultrasonic converter by pressing **Start** (see the picture below). First press on the **Start** button will find and memorize the proper, **average operating frequency**, which corresponds to the selected **phase-difference** value. Generator will operate low power, very short time, and stop. In the second activation of the **Start** button, generator will start operating with selected settings (regulating amplitude, phase and frequency).



4. After all settings are tested, we can transfer them to the generator internal memory by using the **Write** button (see below). This is very important operation, because all software settings are still virtual, and present only in the LabVIEW software (on a PC screen), until we transfer them to the internal memory of the generator.



5. Generator can be controlled either manually (rotary encoder + LCD) or from a PC (but not in the same time from both of them).

6. After starting the generator (ultrasonic converter is operating), if everything is well done, the "av" will show certain phase value. The best is when **av** phase is between 30% and 50%. This means that the phase regulator is catching and regulating the expected, optimal operating frequency interval.

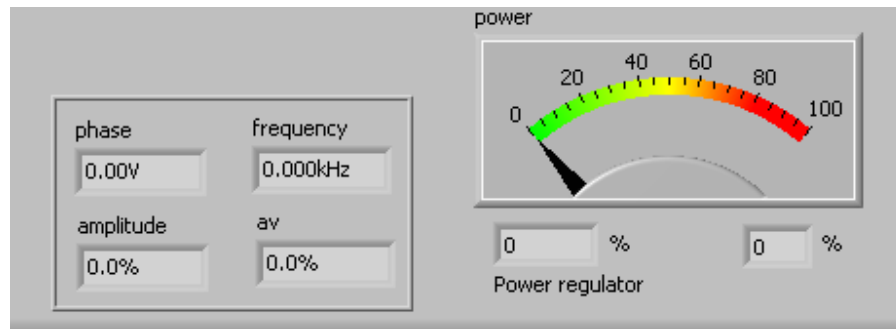

7. If "av" is showing **0** (zero value) this means that starting frequency (f-start) is selected too low. Change f-start and place it slightly higher compared to the value selected before.
8. If "av" is closer to maximal values, either starting frequency is selected too high, or "Span" value is not large enough. Change f-start and **Span** value, until getting **av** between 30% and 50%.
9. **Sweeping** (=) periodical, harmonic sweeping; see the picture below). Here it is possible to adjust the depth of linear, harmonic and periodic (low frequency) sweeping around optimal operating, ultrasonic frequency. It is adjustable from 0 to 1 kHz. This way, ultrasonic operating frequency can be periodically and harmonically modulated inside of 1 kHz interval (by **Sweeping frequency**), depending on selected **Sweeping** value. The repetition rate of the **Sweeping frequency** interval is also adjustable between 0 and 100 Hz. In order to avoid sharp and sudden sweeping variations, we can apply **Smoothing** of the sweeping frequency function.

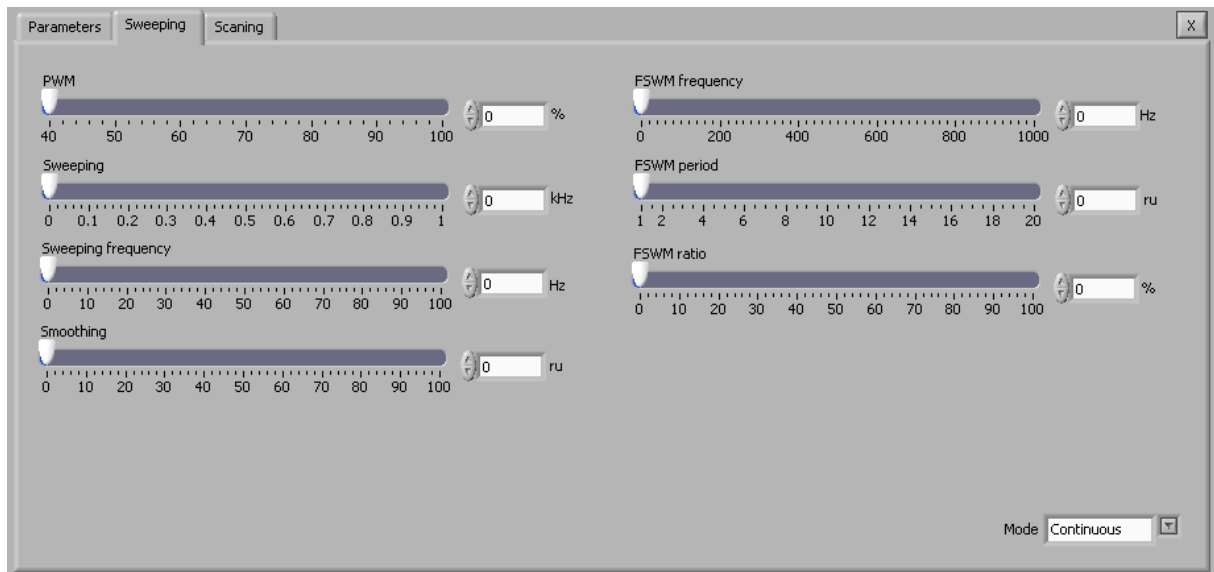

100%-smoothing will transform square-shaped rising-edge frequency sweeping into an exponentially-shaped frequency sweeping (time-wise).

Read – Write options: After all settings are properly and optimally made, we can save the file with such settings using **Write** button (like saving any PC file). Later, we can simply invite/**Read** one of such files (for a specific load) and AMMM generator will start operating as previously memorized.

Literature: [Piezoelectric Transducers Modeling and Characterization \(e-book\)](#)

Practical, short RESUME for low power phase-frequency SCANNING:

First TAB: Initial Software Preparation for SCANNING

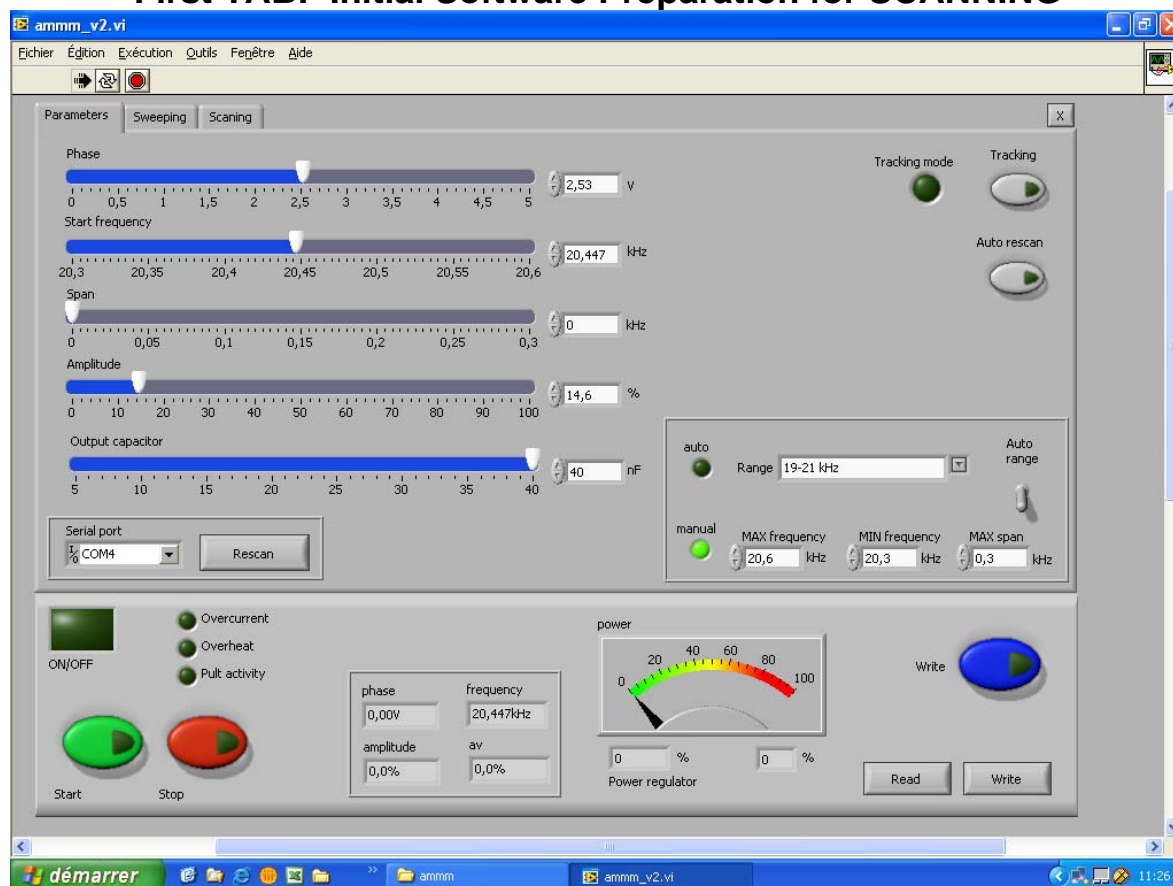

- Install all necessary LabView software (read our manual).
- Activate ammm.exe
- Select proper Serial port (Rescan). Verify that connection to your PC is activated.
- Set output capacitor to minimum (5nF) before scanning
- Select frequency Range, or MIN and MAX frequency & MAX span.
- If Auto frequency range is used, span is automatically selected to be 1 kHz
- Always stop the generator before changing "Output capacitor"
- Do not forget to activate blue button "Write" after every modification

Settings for low power Phase-Frequency Scanning

(safe operating regime;-make settings on the first and second tab):

All of settings are manual

1. Select proper frequency range. Use **auto range** if applicable. If transducer has some other operating frequency interval (not present on auto range), we need to use **manual** settings for $f_{\min.}$ and $f_{\max.}$.
2. Set/write proper **Span = frequency interval** = $f_{\max.} - f_{\min.}$. Write the number either on **manual window** or directly on the **Span window**.
3. Set initial **Phase** for scanning to 2,5 (manually).
4. Set **Start frequency** (manually), on $f_{\max.}$ (this will be maximal scanning frequency). Use the mouse and move cursor to maximal point on the right side where is $f_{\max.}$.
5. Set **Span** (manually) to maximum (= $f_{\max.} - f_{\min.}$). Use the mouse and move the cursor to maximal Span point on the right side.
6. Set **Amplitude** to 0 (= internally software is forcing certain minimal amplitude... about 10%).
7. **When performing low power scanning (using our LabView software), in order to find or estimate optimal frequency range of certain transducer, compensating capacitance should be set on minimum (= 5 nF).**
8. Apply Write Blue Button (data memorized inside the generator) every time after new setting is made.

Second TAB: Initial Software Preparation for SCANNING

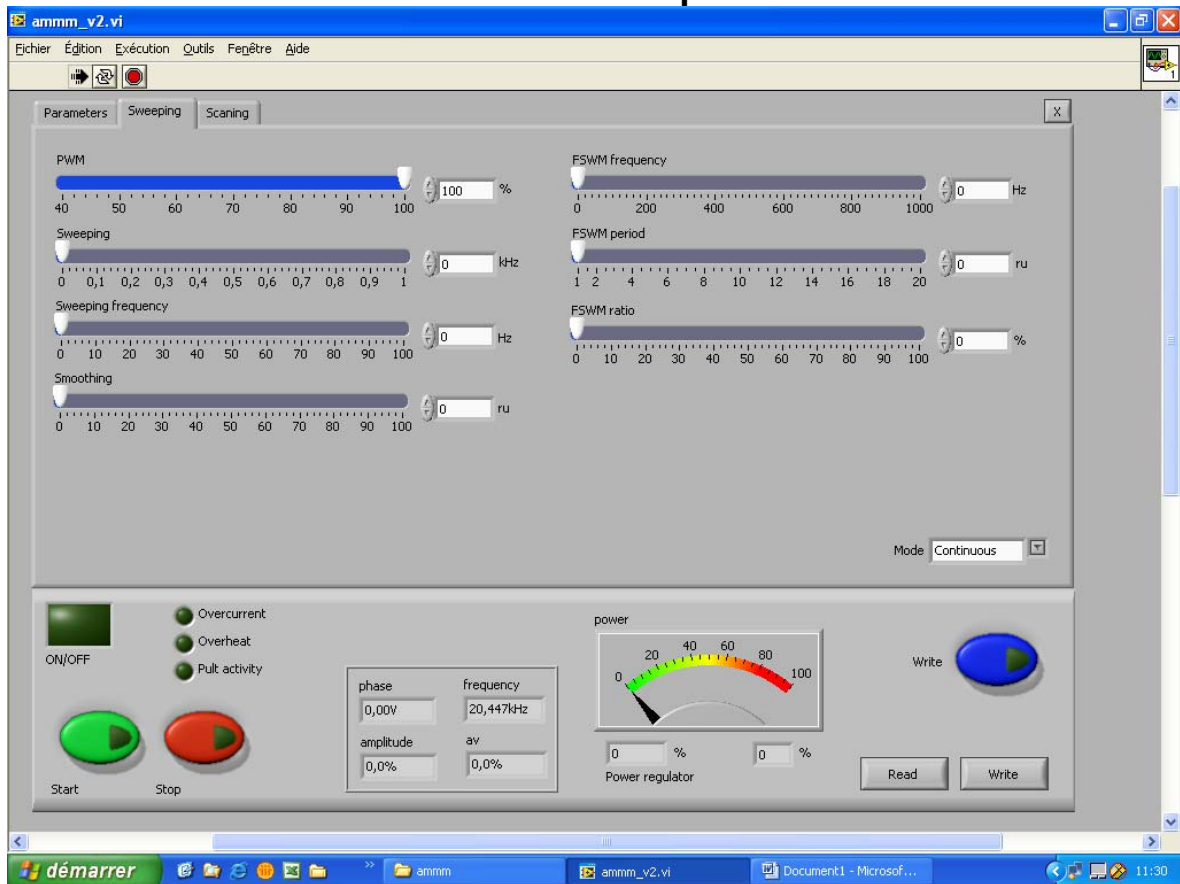

1. Select Mode: **Continuous** (necessary for frequency scanning).
2. Set all other parameters to 0, except PWM
3. Keep PWM on 100%.
9. Apply Write Blue Button (data memorized inside the generator) every time after new setting is made.

Third TAB: Low Power Phase-Frequency Scanning

1. This is only diagnostic/testing safe operating mode to find/see safe operating frequency window. Take only the area that is capturing both high phase peaks.
2. Select new $f_{\min.}$ and $f_{\max.}$ on the first tab (which is completely avoiding high current zones).
3. If **Phase** function (red colour curve) between $f_{\min.}$ and $f_{\max.}$ is irregular, flat, close to zero or has to low values (around 1 and below), such transducer can operate well only in a **FORCED frequency mode**.
4. If **Phase** function is linear, smooth, simple, almost symmetric line with negative slope (between 0 and 5 v), select the phase value that is in the middle point of such linear area. Such transducer can operate in a **continuous, resonance-tracking (almost fixed frequency) mode**.
5. Apply Write Blue Button (data memorized inside the generator) every time after new setting is made.
6. Generally (in most of cases) apply initial Scanning when ultrasonic system is in no-load (= Air load) conditions. This is always valid for transducers and ultrasonic loads operating in a **continuous, resonance-tracking mode**. Results found for no-load conditions will be later applied for real operating (under loading) in a **continuous, resonance-tracking mode**. For such mode, we will not make scanning under loading (frequency window found in no-load conditions will be equal to the real operating frequency window under loading).
7. If we find that certain ultrasonic system should operate only in a **FORCED mode**, in such cases we can first apply **no-load scanning** and then **scanning under loading** (when we will find different safe operating frequency windows). In most of such cases, relevant results will be related to frequency window found with scanning under ultrasonic loading. Do not forget later (in a high power operating regime) to apply **periodic** or **AMMM** mode.

Literature: [Piezoelectric Transducers Modeling and Characterization \(e-book\)](#)

Examples of proper selection of operating frequency ranges (during Scanning)

If you have impedance analyzer, make impedance measurements and select initial scanning range that will capture both series and parallel resonant frequency and little bit wider (on both sides).

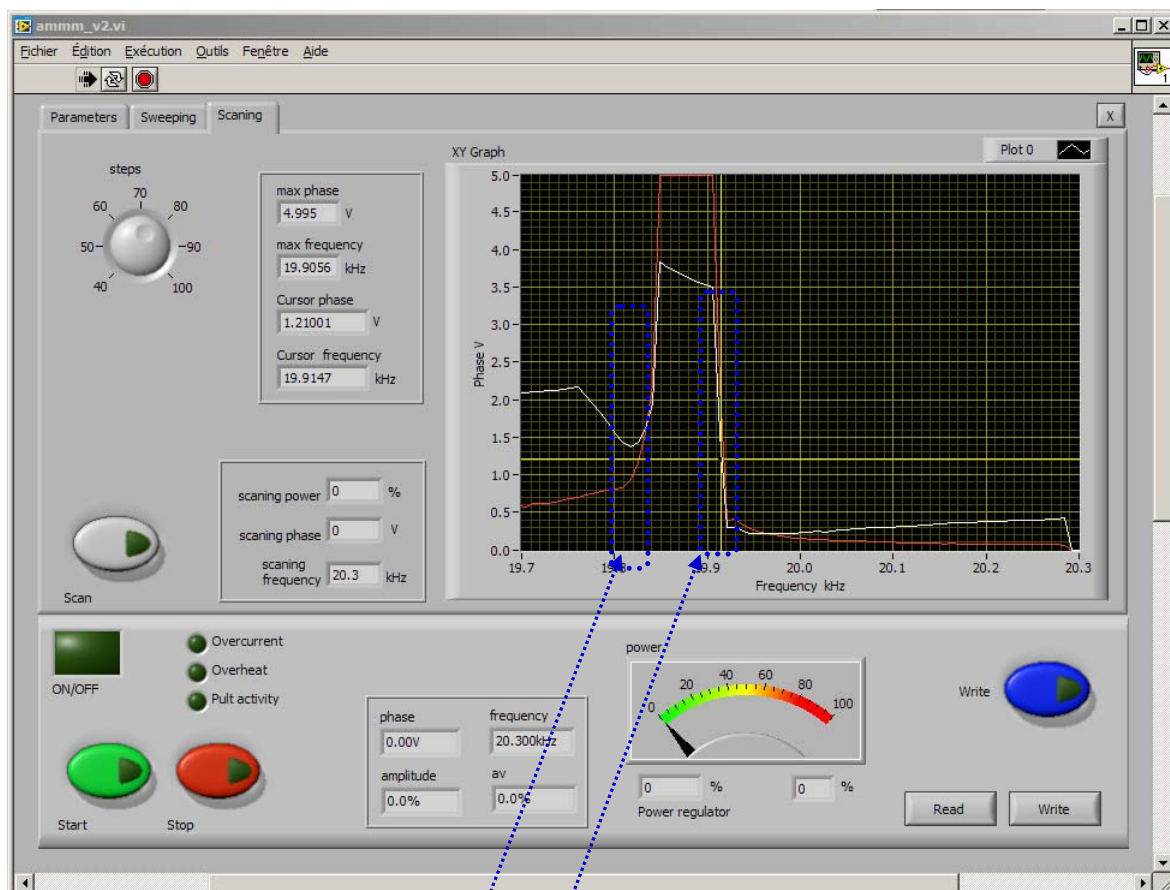

Fig. 1. Typical scanning curve (wide scanning range).

Somewhere in this area is series resonance (here, close to 19.82 kHz)

Somewhere in this area is parallel resonance (here, close to 19.92 kHz)

Before performing scanning, set amplitude to 0 (zero), set output capacitor to minimum (5 nF), set operating mode to "continuous", disable all sweeping parameters (set them to 0), set operating frequency range (minimal and maximal frequency and Span) inside the expected operating frequency interval.

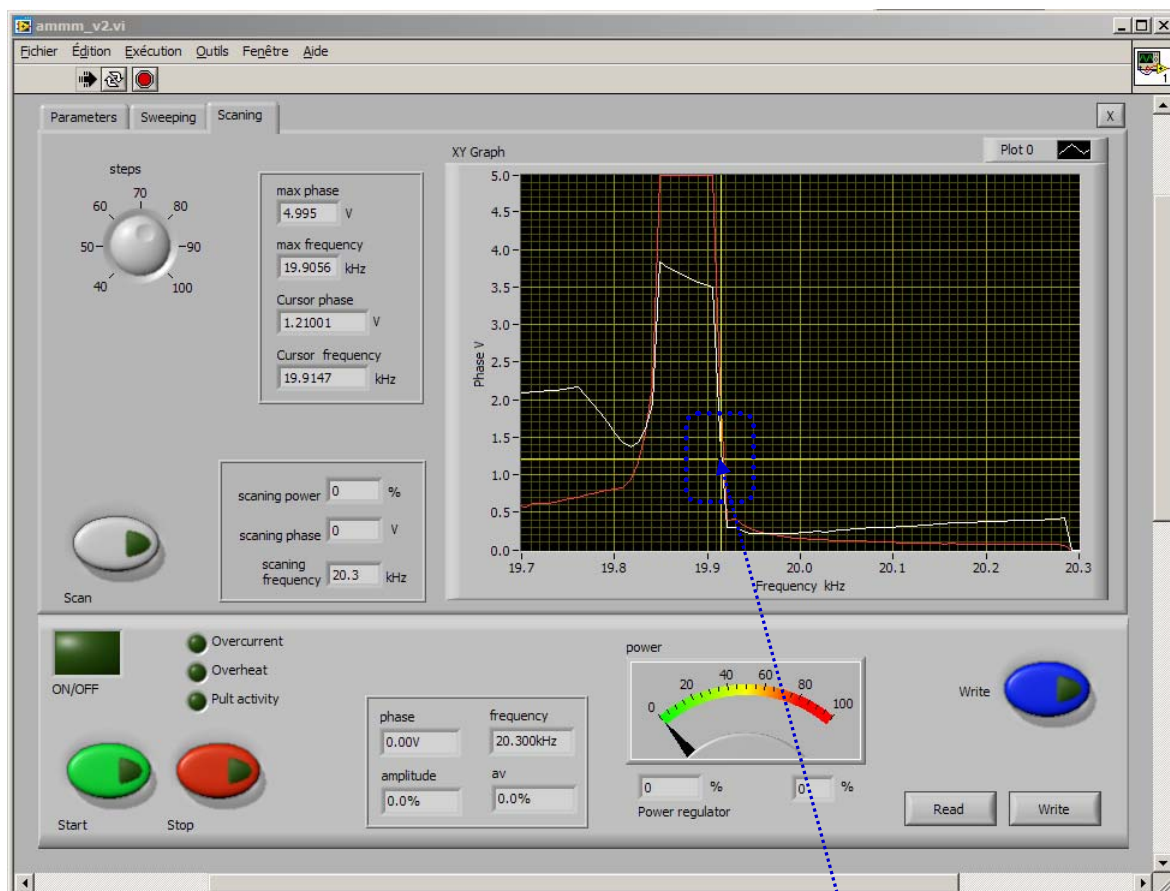

Fig. 2. Typical scanning curve (wide scanning range).

Somewhere in this area, it will be the best to select **set point for phase regulation**. For example, on this curve optimal phase values are between 0.5 and 2 V. Here selected optimum is 1.25 V.

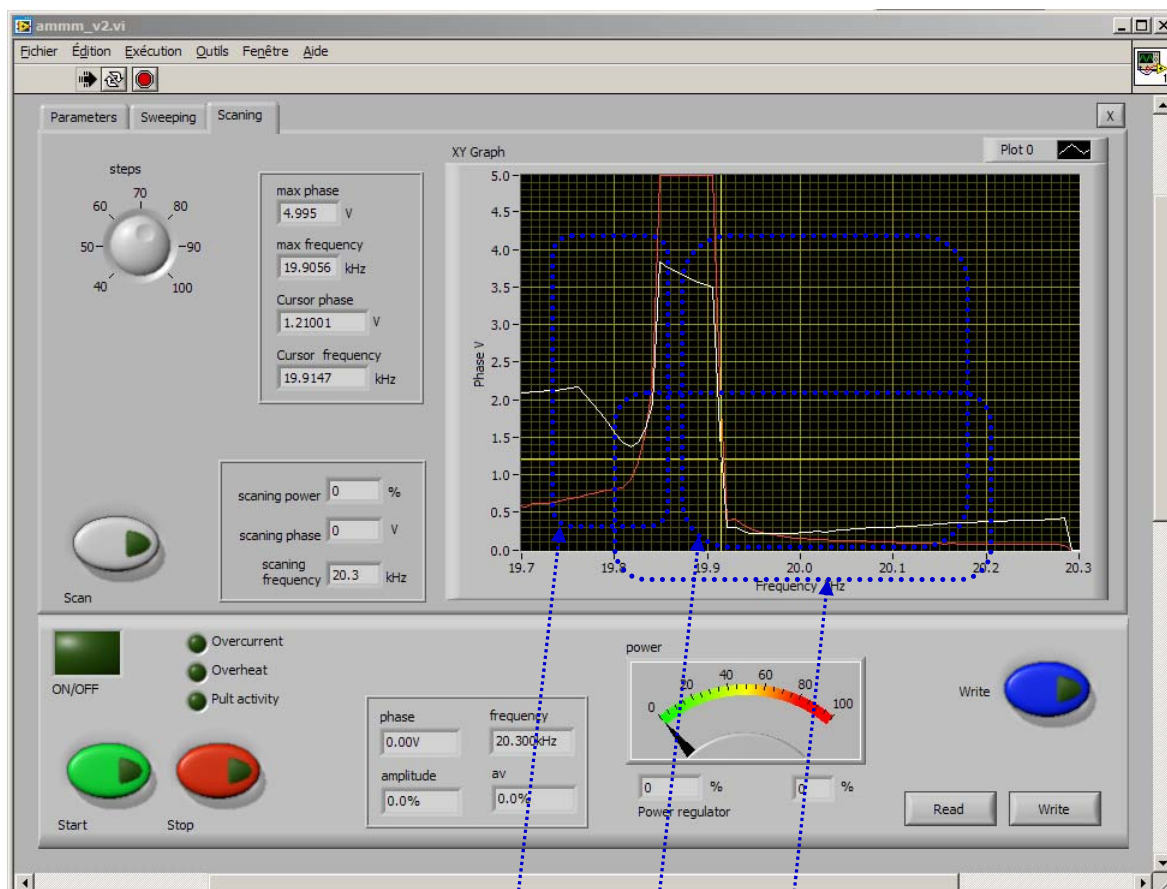

Fig. 3. Typical scanning curve (wide scanning range).

Here is relatively safe operating frequency area. Frequency capture range should be reduced to here-encircled area. For instance, in this case, proper selection for safe operating frequency area is from 19.82 to 20.23 kHz. This is good operating frequency area for very high power plastic welding, Sonochemistry, liquids processing and similar applications. Whenever operating frequency area (or frequency Span) is overlapping series resonant frequency, this presents potentially risky operating regime, which should be well tested. Operating frequency in this area will be automatically regulated from parallel resonant frequency to series resonant frequency and towards lower frequency values.

If we like to select **operating regime only in the close vicinity of parallel resonance**, operating frequency range (and frequency Span) should be selected like here. Series resonance should be excluded by setting minimal frequency (sufficiently high). This will be the safest operating regime for low and moderate acoustic loads, for welding, Sonochemistry, liquids atomizing and powders sieving applications, as well as for operating high amplitude in air. This operating regime has very high oscillating amplitudes and high oscillating velocity.

Here is **the most powerful, most risky and heavy-duty, high stress operating frequency range**. Converter has increased heat dissipation in this area. Do not operate converter in air or low load conditions, here. Converter should be fully loaded before being activated in this frequency area. Avoid operating in this area whenever possible and not absolutely necessary.

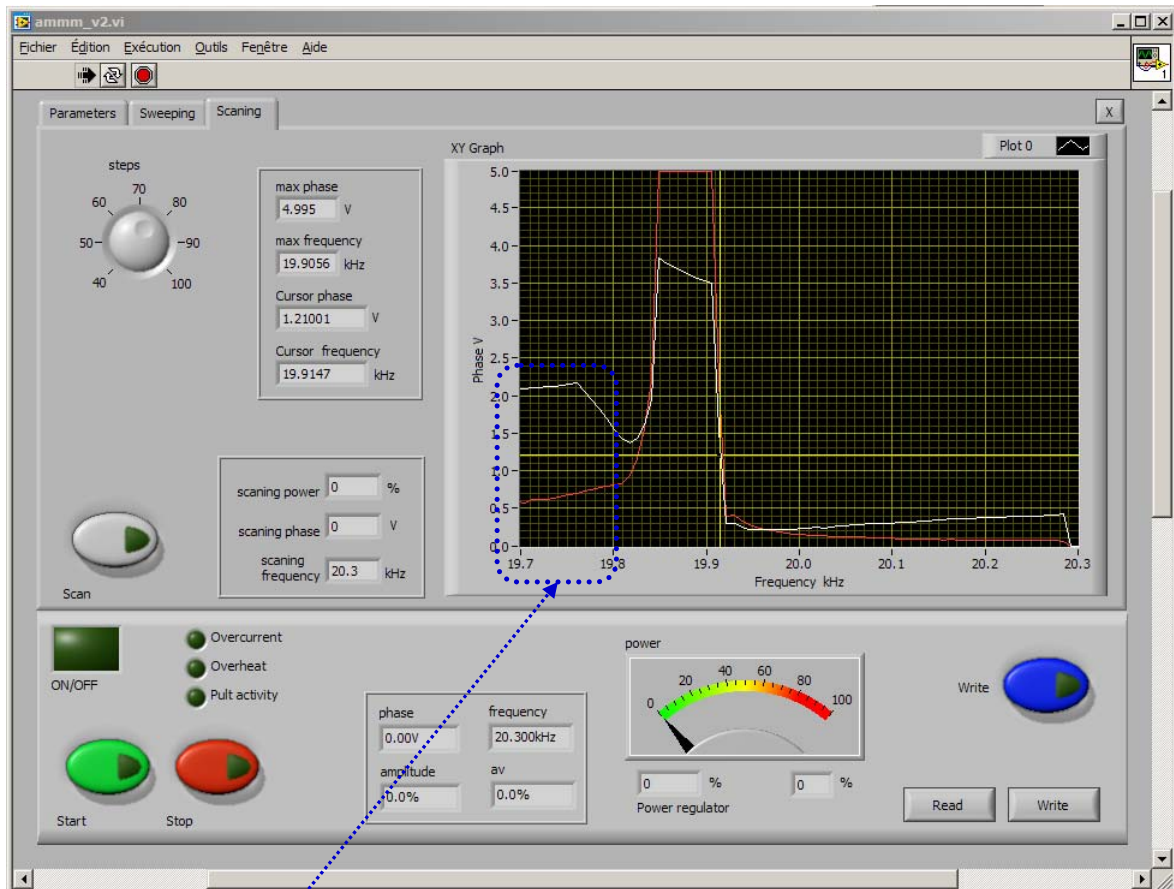

Fig. 4. Typical scanning curve (wide scanning range).

Here is very risky frequency area (high stress, high amplitude, increased converter heating, high oscillatory pressure). Better to avoid this area. This is the area below series resonant frequency. Be very careful if operating in this area. Operate here only under heavy loading (not in air), like in cases of metal welding applications.

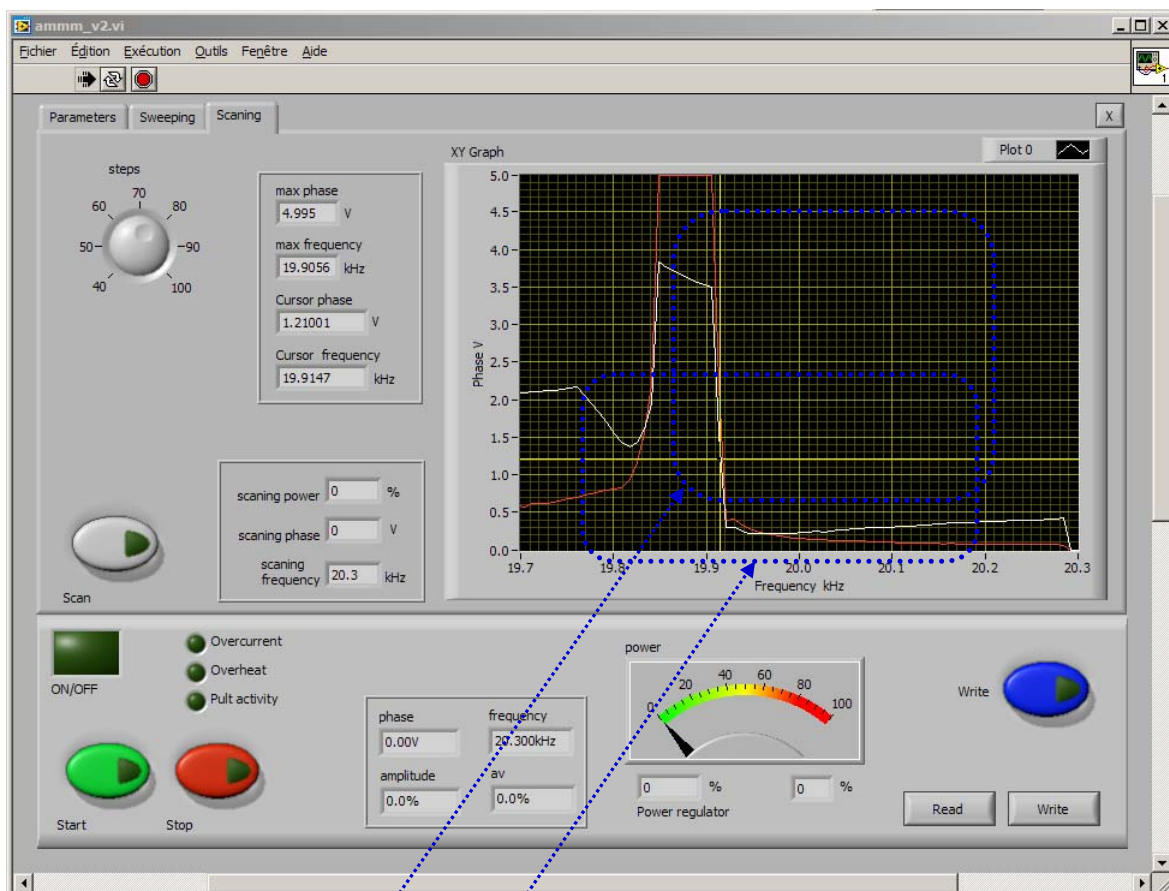

Fig. 5. Typical scanning curve (wide scanning range).

Select this **frequency area for heavy-duty operations under loading** (like metals welding). Here selected frequency range is from 19.79 to 20.21 kHz. **Do not operate in air.** Whenever operating frequency area (or frequency Span) is overlapping series resonant frequency, this presents potentially risky operating regime, which should be well tested. Operating frequency in this area will be automatically regulated from parallel resonant frequency to series resonant frequency and towards lower frequency values.

Select the frequency interval that covers only parallel resonance and higher frequencies, and does not cover series resonance. **This is the safest operating regime for low and moderate acoustic loads**, for welding, Sonochemistry, liquids atomizing and powders sieving applications, as well as for operating high amplitude in air. This operating regime has very high oscillating amplitudes and high oscillating velocity.

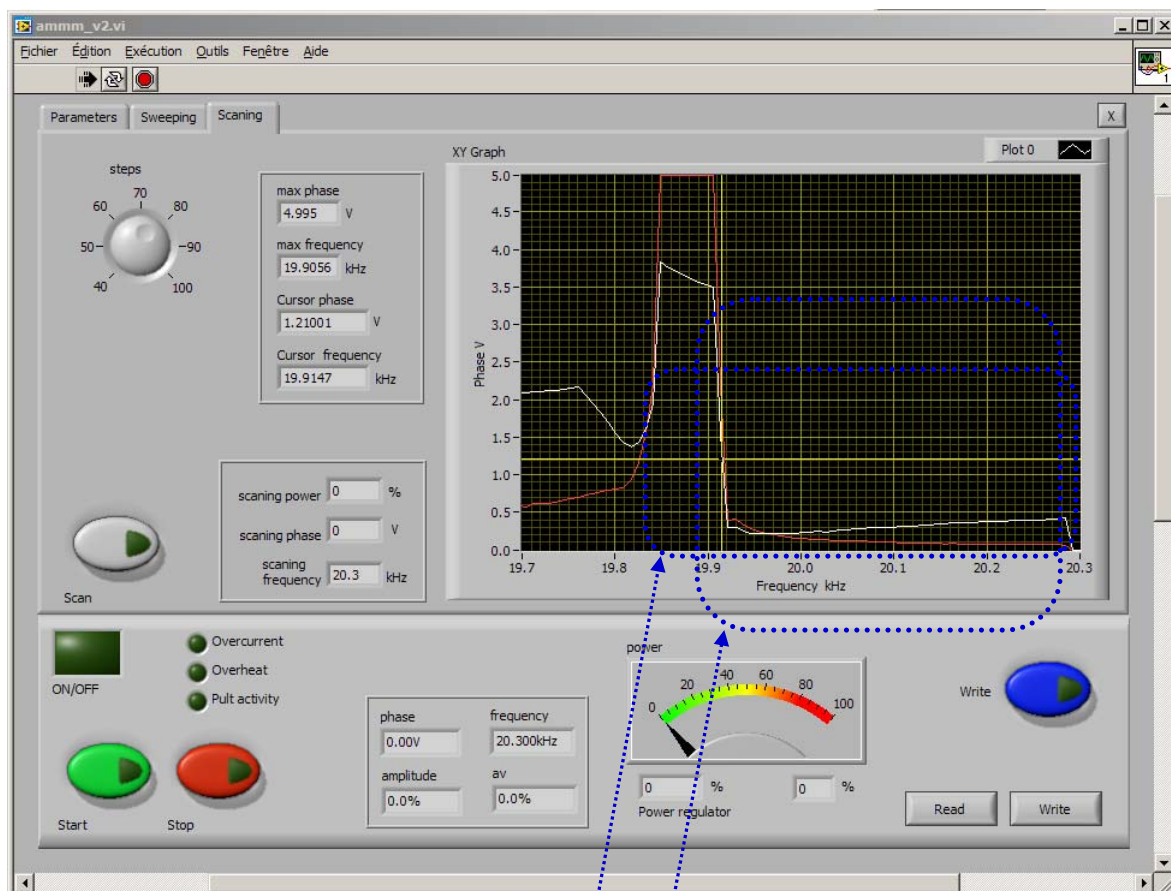

Fig. 6. Typical scanning curve:(wide scanning range).

Select this **frequency area for continuous operating under moderate and high power loading** (like for welding and liquids processing). Here selected safe frequency range is from 19.84 to 20.3 kHz.

Select the frequency interval that covers only parallel resonance and higher frequencies, and does not cover series resonance. **This is the safest operating regime for low and moderate acoustic loads**, for welding, Sonochemistry, liquids atomizing and powders sieving applications, as well as for operating high amplitude in air. This operating regime has very high oscillating amplitudes and high oscillating velocity.

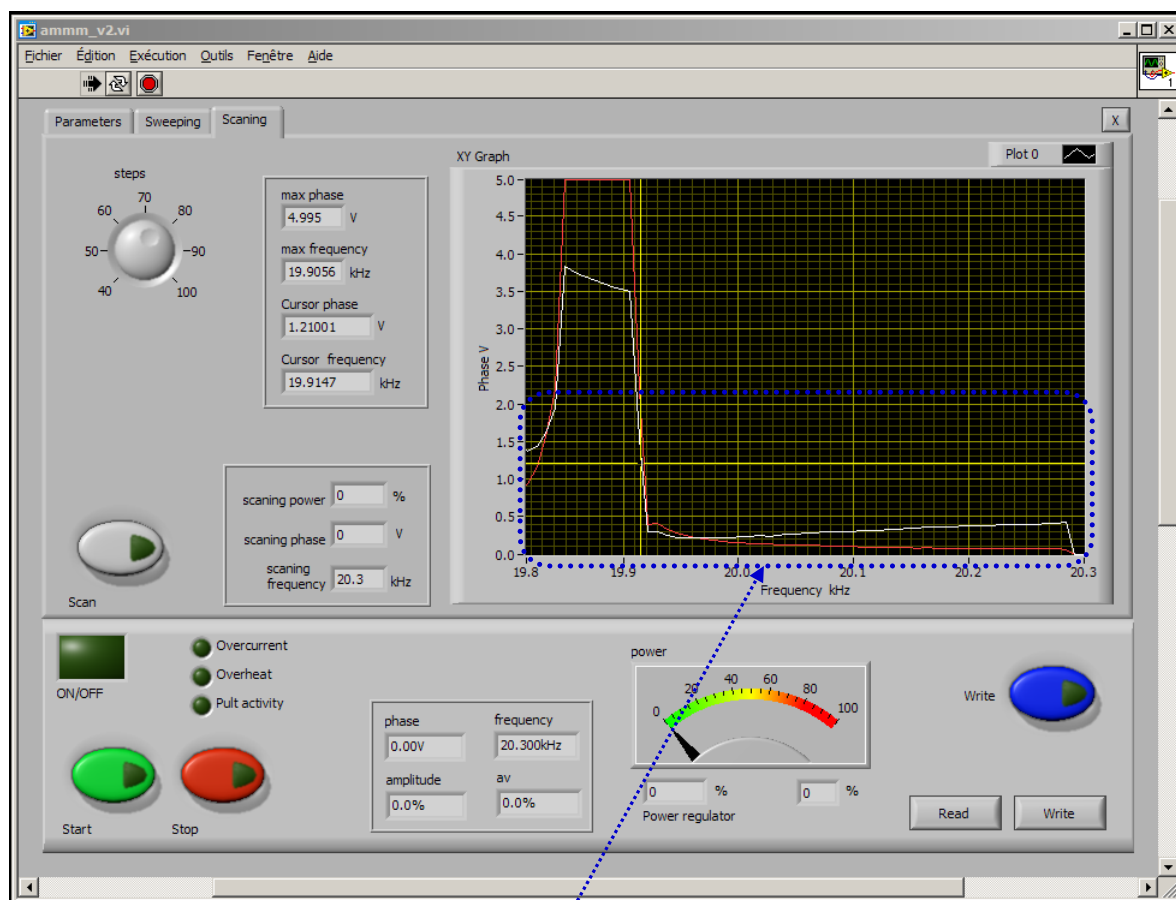

Fig. 7. Typical scanning curve (optimal, safe operating range).

Here is **well-selected (total), safe frequency capture and regulation area for most of high power welding and liquid processing applications.** Whenever operating frequency area (or frequency Span) is overlapping series resonant frequency, this presents potentially risky operating regime, which should be well tested. Operating frequency in this area will be automatically regulated from parallel resonant frequency to series resonant frequency and towards lower frequency values.

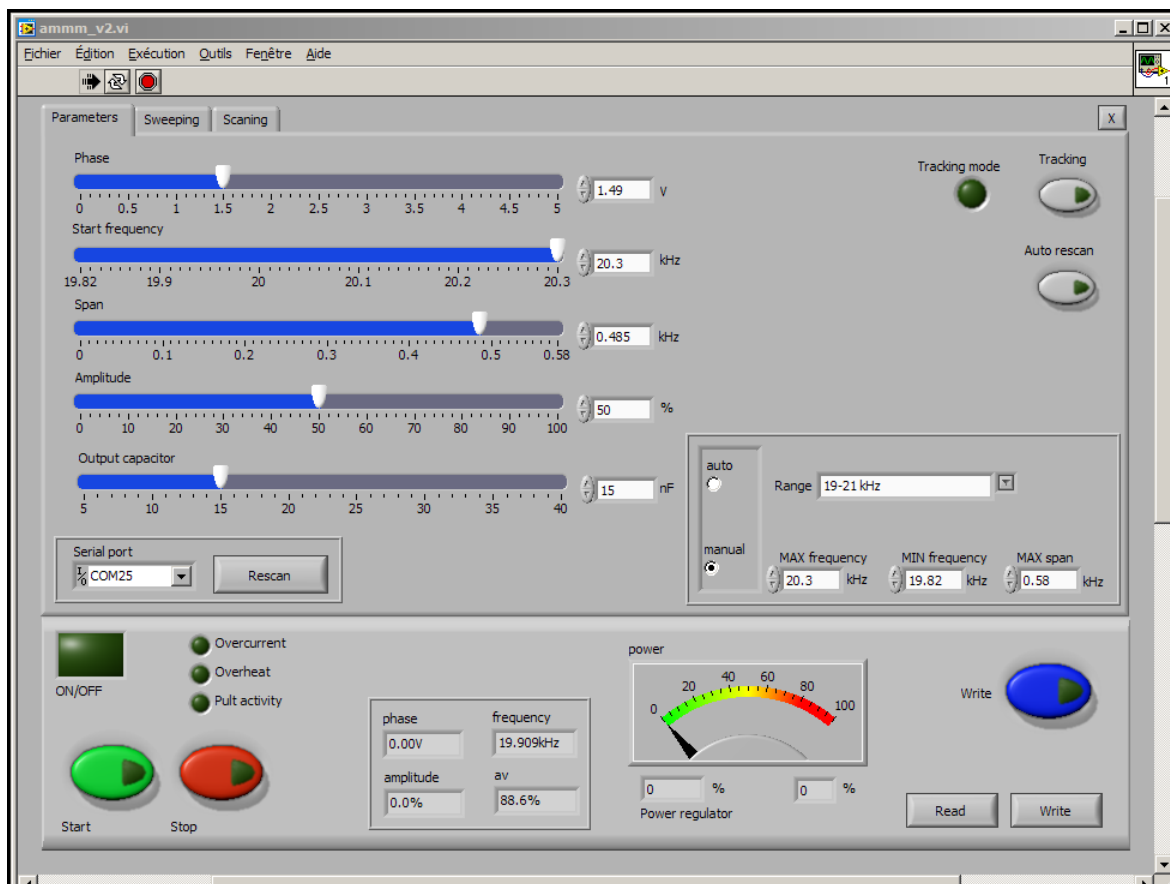

Fig. 8. Setting Parameters selected based on scanning and application

Operating situation after scanning: First TAB (parameters)

- Increase output capacitor gradually, as long automatic amplitude and phase regulation is operating correctly.
- For first Start select Amplitude to 20%, later increase... First Start will repeat and verify Scanning and if everything is OK, generator will stop without generating error message. Second Start (green button) will activate converter.
- In case if/when adding/changing booster/sonotrode/converter, repeat scanning
- Later follow manual.
- Always stop the generator before changing "Output capacitor"
- Do not forget to activate blue button "Write" after every modification

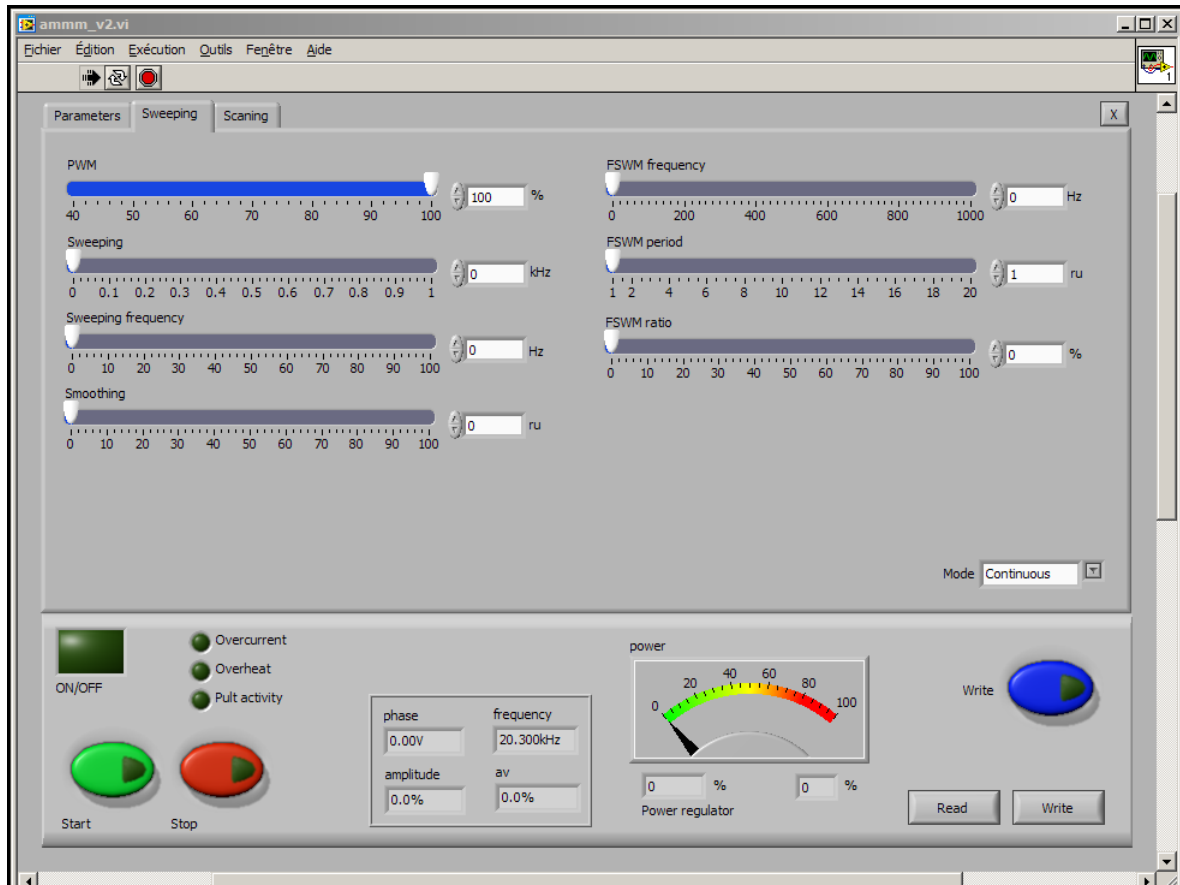

Fig. 9. Sweeping parameters are disabled for scanning and for welding applications (like on this picture). Select continuous mode before scanning.

- Set all values to « 0 » or to minimum before scanning
- Set PWM to 100%
- Do not forget to activate blue button "Write" after every modification

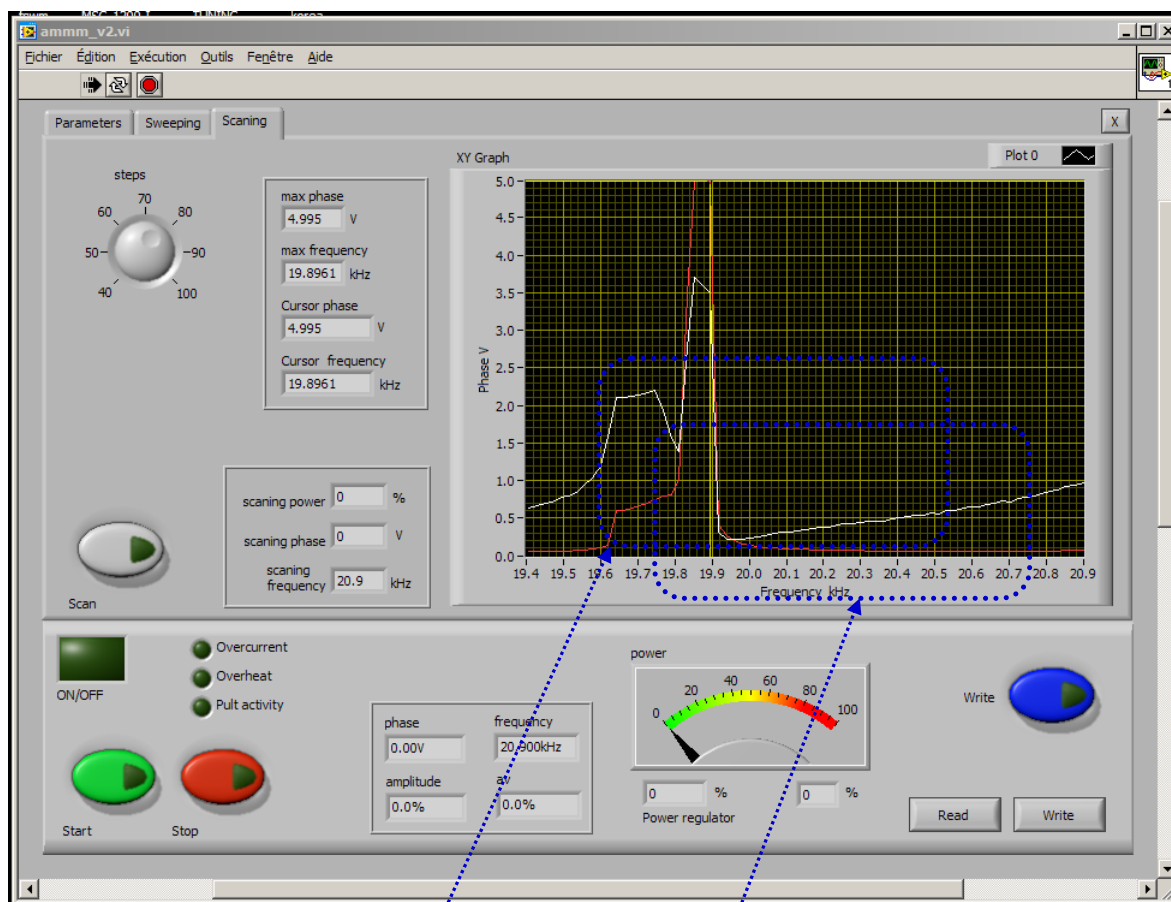

Fig. 10. Another example of very wide frequency interval scanning

Well selected frequency capture area for most of moderate and high power applications.

Frequency area for metals welding and other heavy-duty applications under loading (do not operate in air).

Whenever operating frequency area (or frequency Span) is overlapping series resonant frequency, this presents potentially risky operating regime, which should be well tested. Operating frequency in this area will be automatically regulated from parallel resonant frequency to series resonant frequency and towards lower frequency values.

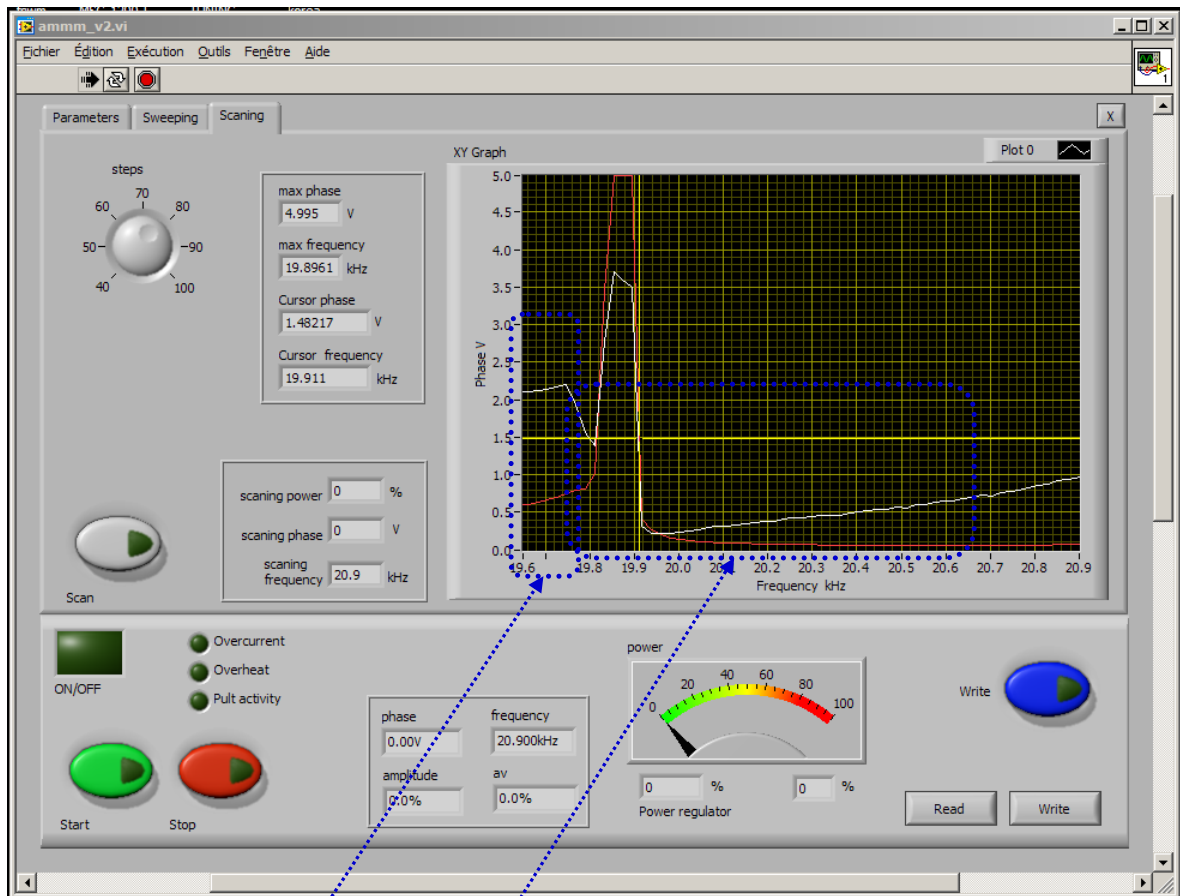

Fig. 11. **Heavy-duty frequency operating area** (operate only under loading)
Here is very risky, high stress operating area. Avoid operating here.

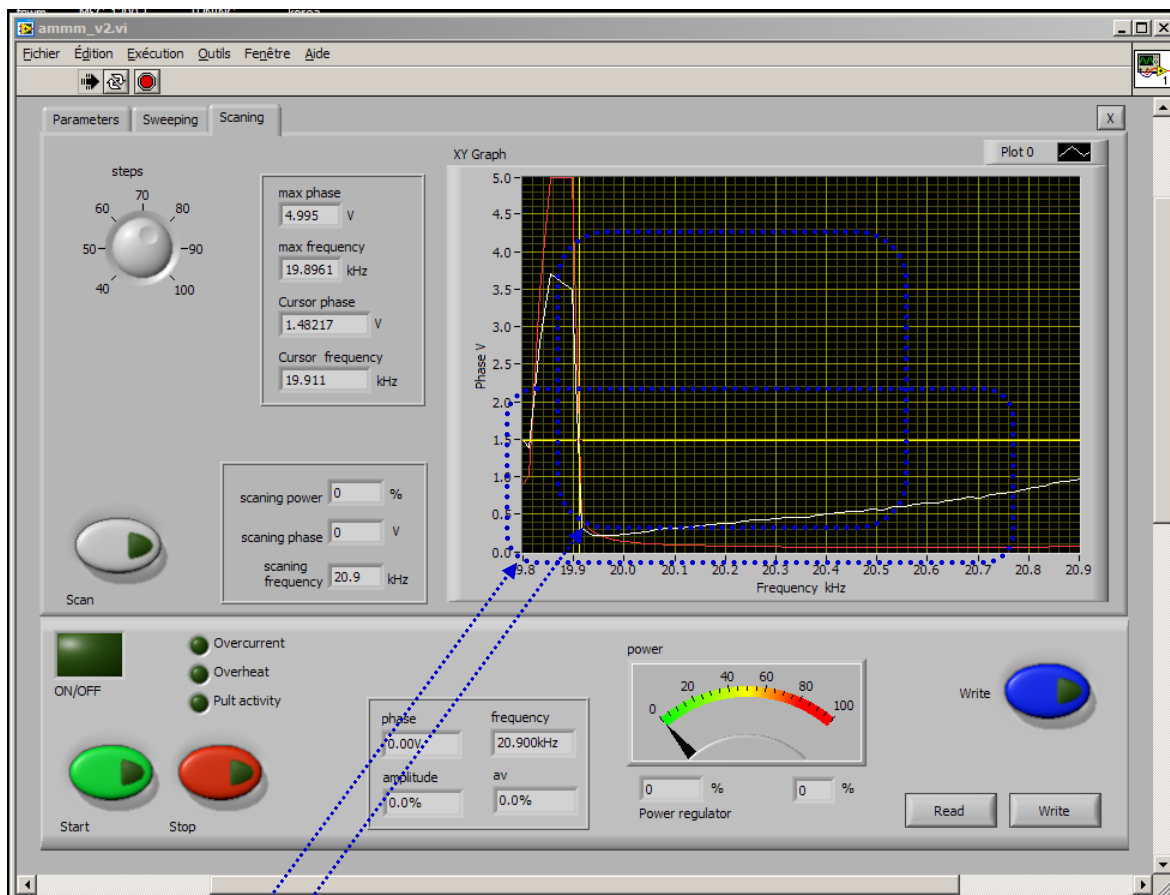

Fig. 12. **Wide-moderate and high power frequency operating area** (for most of applications)

Select the frequency interval that covers only parallel resonance and higher frequencies, and does not cover series resonance. **This is the safest operating regime for low and moderate acoustic loads**, for welding, Sonochemistry, liquids atomizing and powders sieving applications, as well as for operating high amplitude in air. This operating regime has very high oscillating amplitudes and high oscillating velocity.

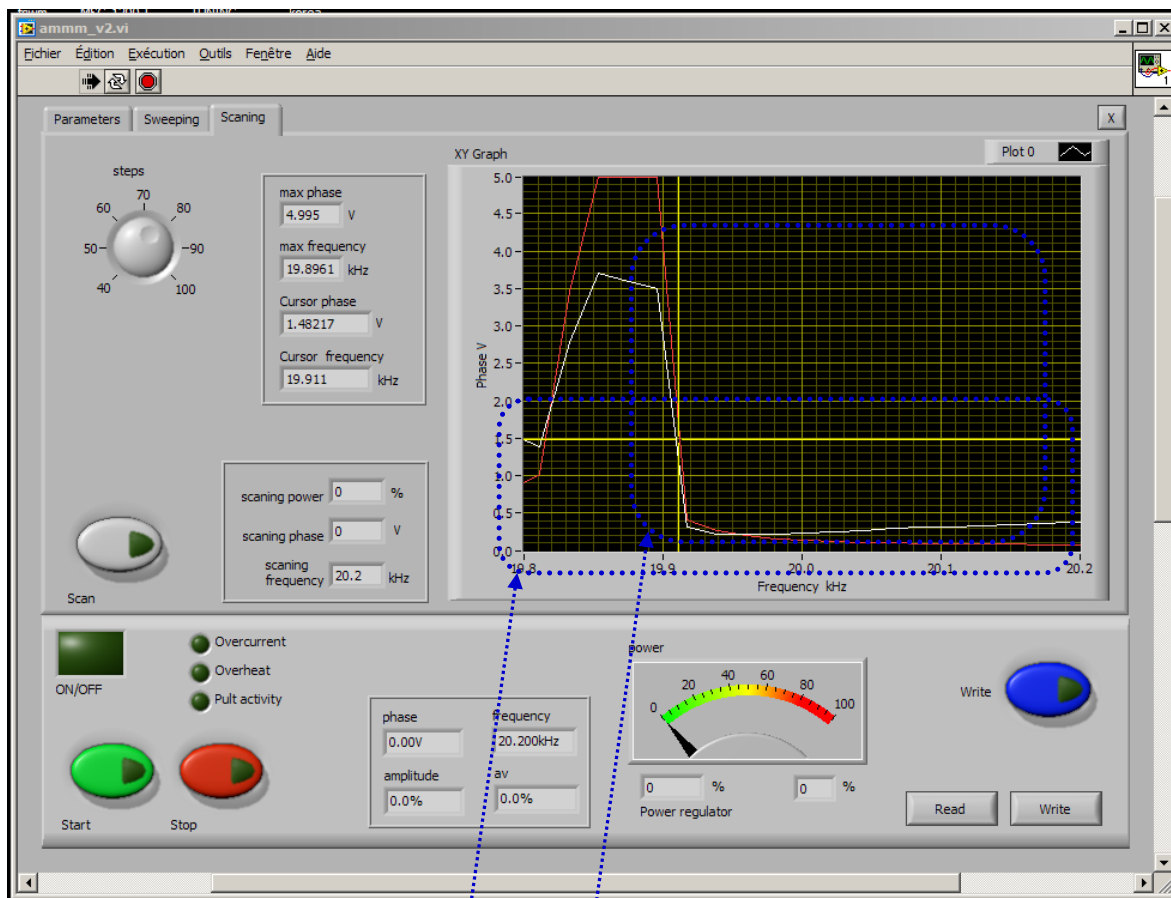

Fig. 13. **Well-selected frequency operating area for moderate and high power** (for most of applications)

Select the frequency interval that covers only parallel resonance and higher frequencies, and does not cover series resonance. **This is the safest operating regime for low and moderate acoustic loads**, for welding, Sonochemistry, liquids atomizing and powders sieving applications, as well as for operating high amplitude in air. This operating regime has very high oscillating amplitudes and high oscillating velocity.

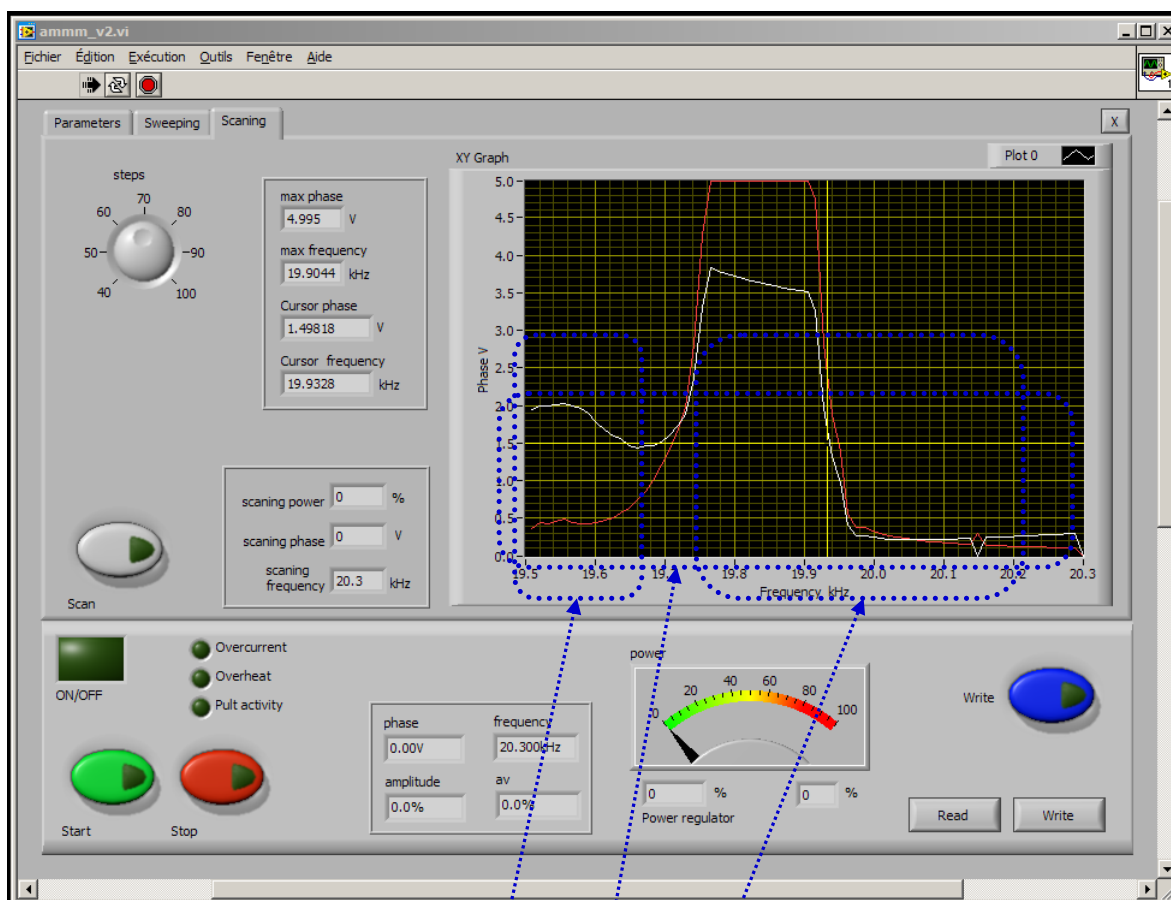

Fig. 14. Frequency **operating area for high power, heavy-duty** (for metals welding applications). Operate only under loading (**not in air**). Risky operating regime.

In all cases when series resonant frequency and certain frequency interval below is captured, this is presenting **very risky operating zone**. Test carefully and modify parameters until safe operating regime is found.

Moderate power, safe-operating frequency area (operating in air, for atomizing and powders sieving applications)

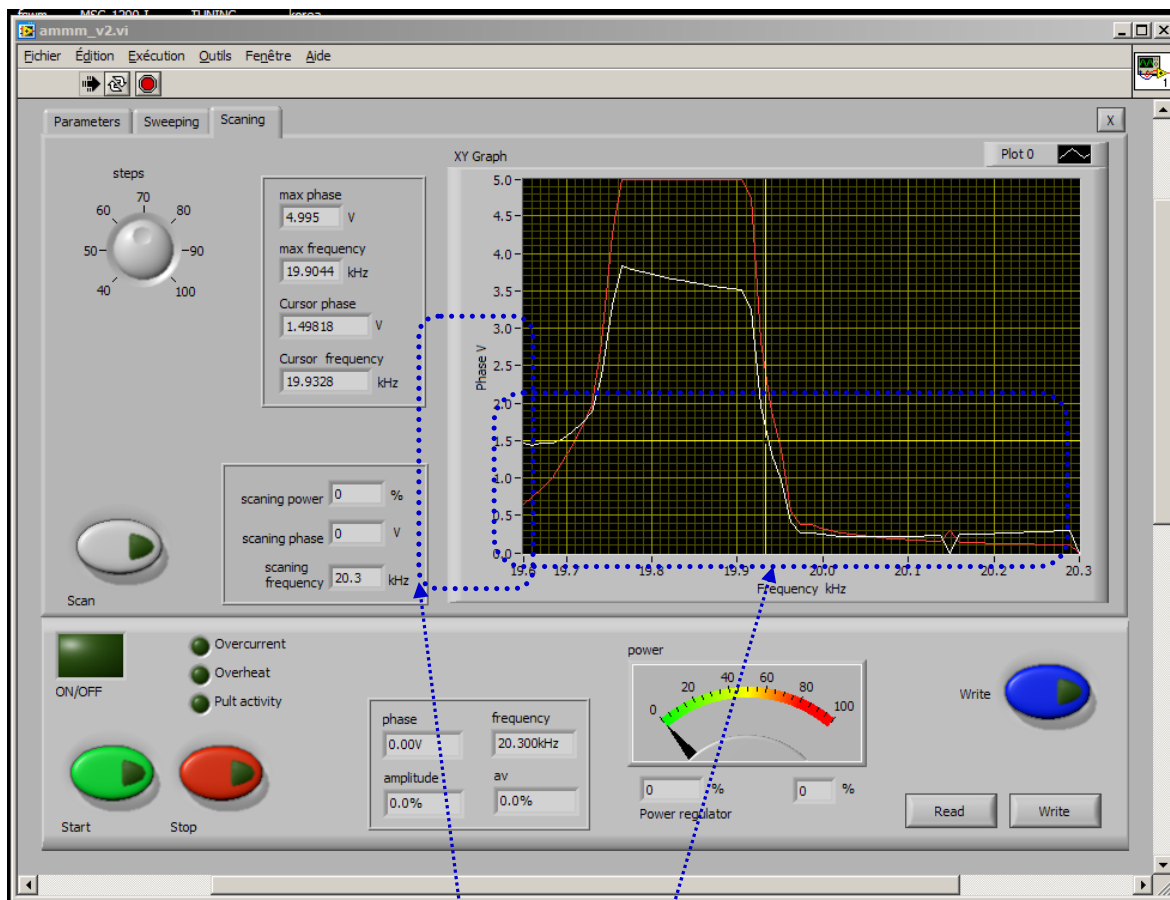

Fig. 15. **Well-selected frequency operating area** for moderate and high power (for most of applications)

On this frequency-capture-range, **frequency area below series resonance is avoided.**

Select the frequency interval that covers only parallel resonance and higher frequencies, and does not cover series resonance. **This is the safest operating regime for low and moderate acoustic loads,** for welding, Sonochemistry, liquids atomizing and powders sieving applications, as well as for operating high amplitude in air. This operating regime has very high oscillating amplitudes and high oscillating velocity.

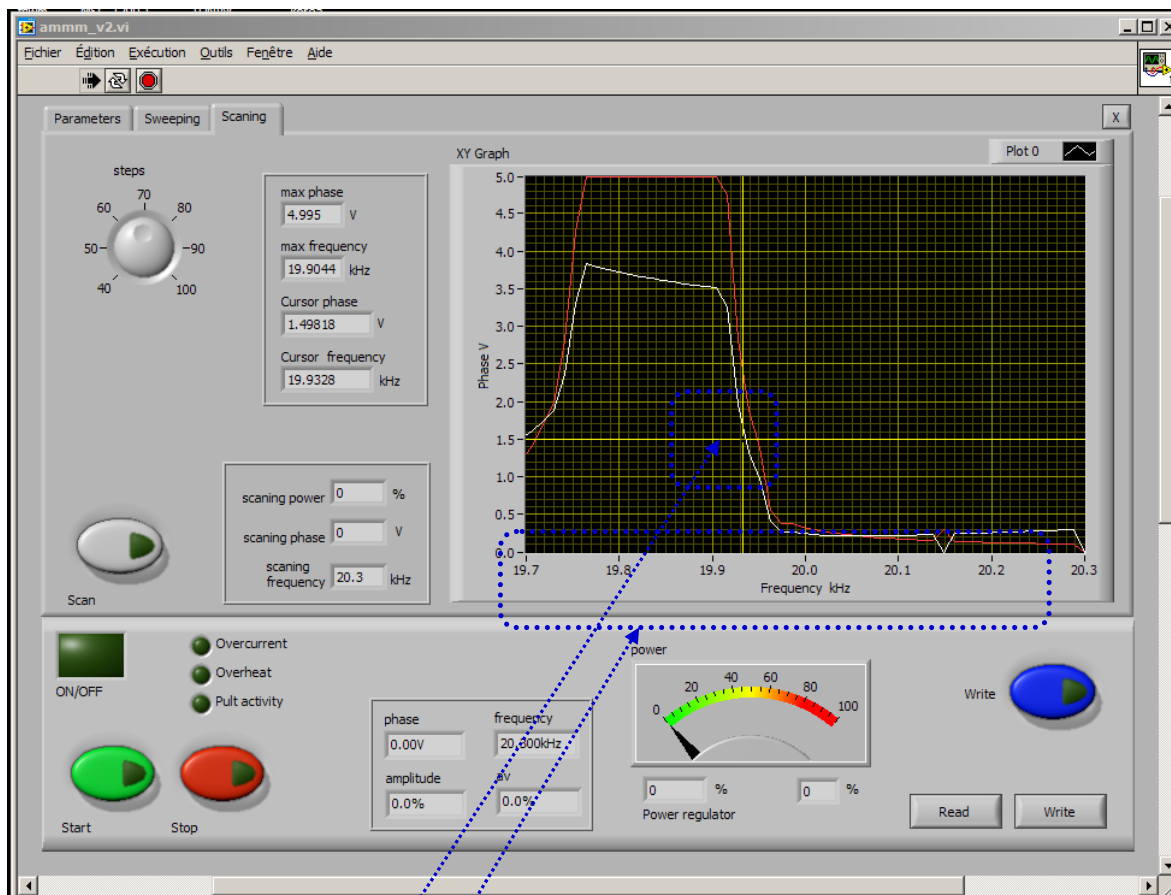

Fig. 16. **Well selected phase set point** (here 1.5 V). Should always be selected in a lower linear zone of phase curve with negative slope.

This is very well-selected frequency area for most of moderate and high power applications.

Select the frequency interval that covers only parallel resonance and higher frequencies, and does not cover series resonance. **This is the safest operating regime for low and moderate acoustic loads**, for welding, Sonochemistry, liquids atomizing and powders sieving applications, as well as for operating high amplitude in air. This operating regime has very high oscillating amplitudes and high oscillating velocity.

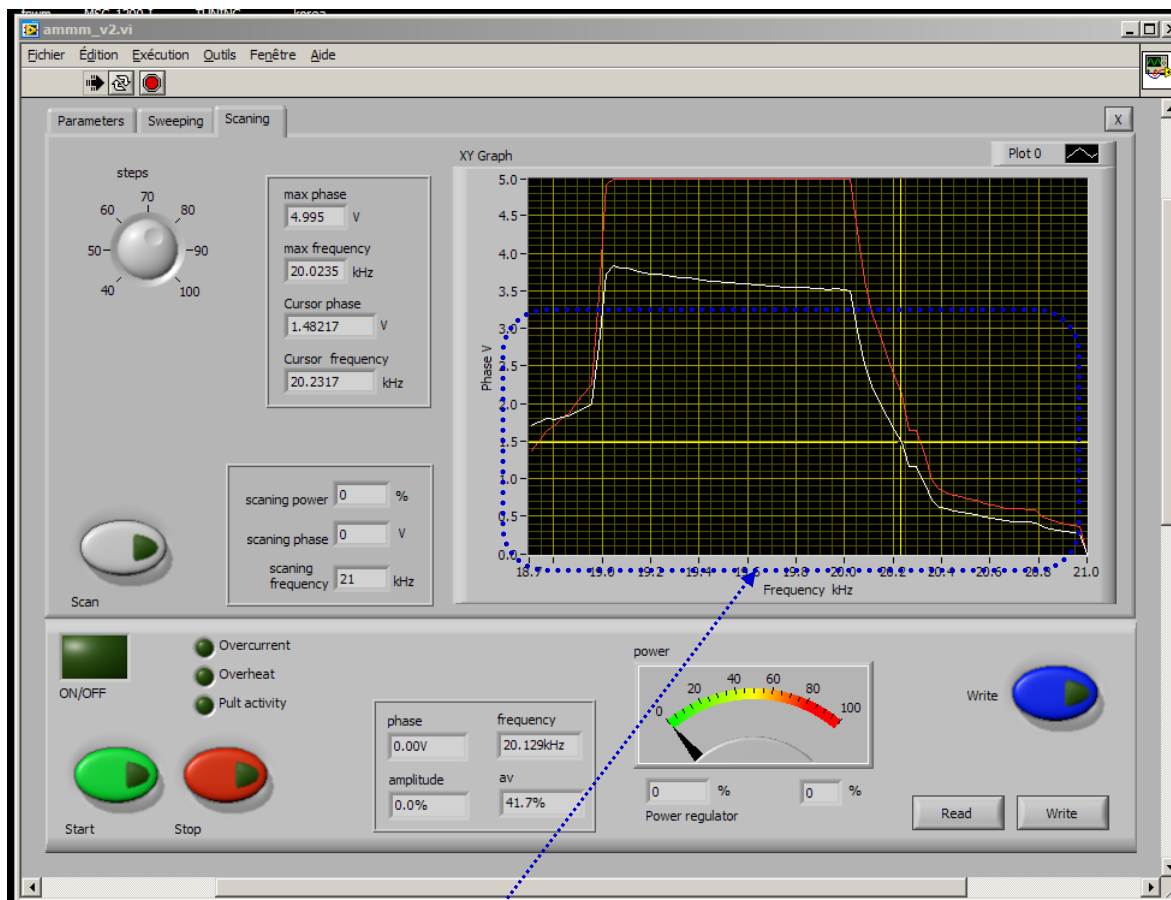

Fig. 17. **Well selected, reduced frequency operating area** for moderate and high power (for most of applications) and for very fast welding (start-up transient time between two welds is very short).

Select the frequency interval that covers only parallel resonance and higher frequencies, and does not cover series resonance. **This is the safest operating regime for low and moderate acoustic loads**, for welding, Sonochemistry, liquids atomizing and powders sieving applications, as well as for operating high amplitude in air. This operating regime has very high oscillating amplitudes and high oscillating velocity.

Very good settings strategy for reaching optimal operating conditions

1. If you have impedance analyzer, make impedance measurements and select initial scanning range that will capture both series and parallel resonant frequency and little bit wider (on both sides).
2. Measure and/or calculate the frequency interval between series and parallel resonant frequency $\Delta f = f_p - f_s = f_2 - f_1$
3. Set the **Span** value (on the first settings tab) to be between $\Delta f < \text{Span} < 6\Delta f$, (optimal Span could be between 2 and 4 Δf). Test later different Span values and select one that is producing optimal operating conditions.
4. Initially set the **Start frequency** to be in the low phase, low current zone (far from any other resonance), and to have the value $f_{\text{start}} \leq f_p + 3\Delta f = f_s + 4\Delta f$ (below maximal frequency).

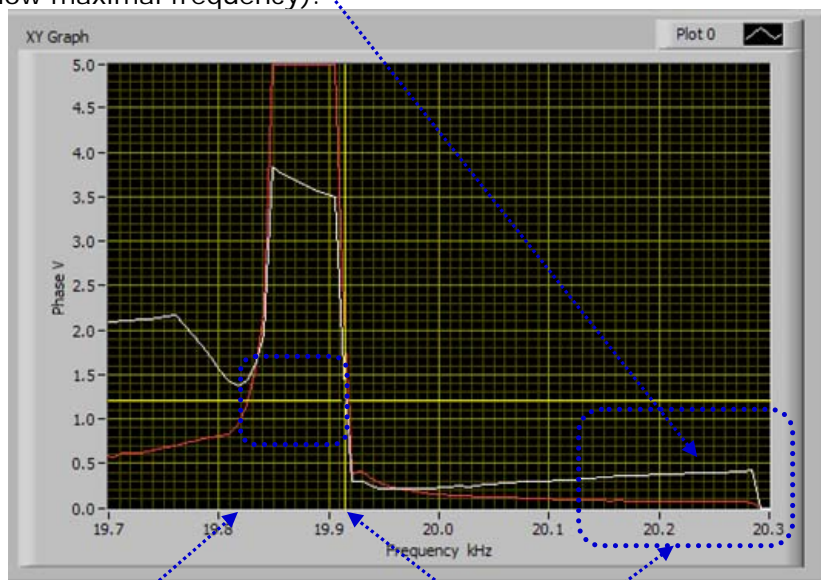

Fig. 2. Typical scanning curve (wide-scanning range).

Here is series resonant frequency f_s . Here is parallel resonant frequency f_p .

Select Start frequency somewhere here

5. Make all scanning, testing and tuning as already explained in this manual, while also respecting points 1, 2, 3 and 4 (see above on this page).
6. Test the generator and verify if amplitude and phase are being regulated correctly (and automatically). Try operating mostly around parallel resonance.
7. Readjust only start frequency going from higher to lower frequencies until reaching proper and stable, automatic regulation of **phase** and **amplitude**. Do not increase the Span. Optimal operating conditions in this case will found only by readjusting start frequency. All other setting parameters will stay unchanged as previously selected).

EXTREMELY IMPORTANT

The most important (unavoidable, ultimate objective) for resonance or frequency-phase tracking modes is to achieve stable, automatic, real time phase and amplitude regulation when transducer is loaded (and operating on a sufficiently high power, above the critical power threshold).

To recognize that we realized such operating regime we should compare:

- a) **Phase set point value** with the actual, real-time **regulated phase value** and the **numbers in both windows should be almost the same.**
- b) **Amplitude set point value** with the actual, real-time **regulated amplitude value** and the **numbers in both windows should be almost the same.**

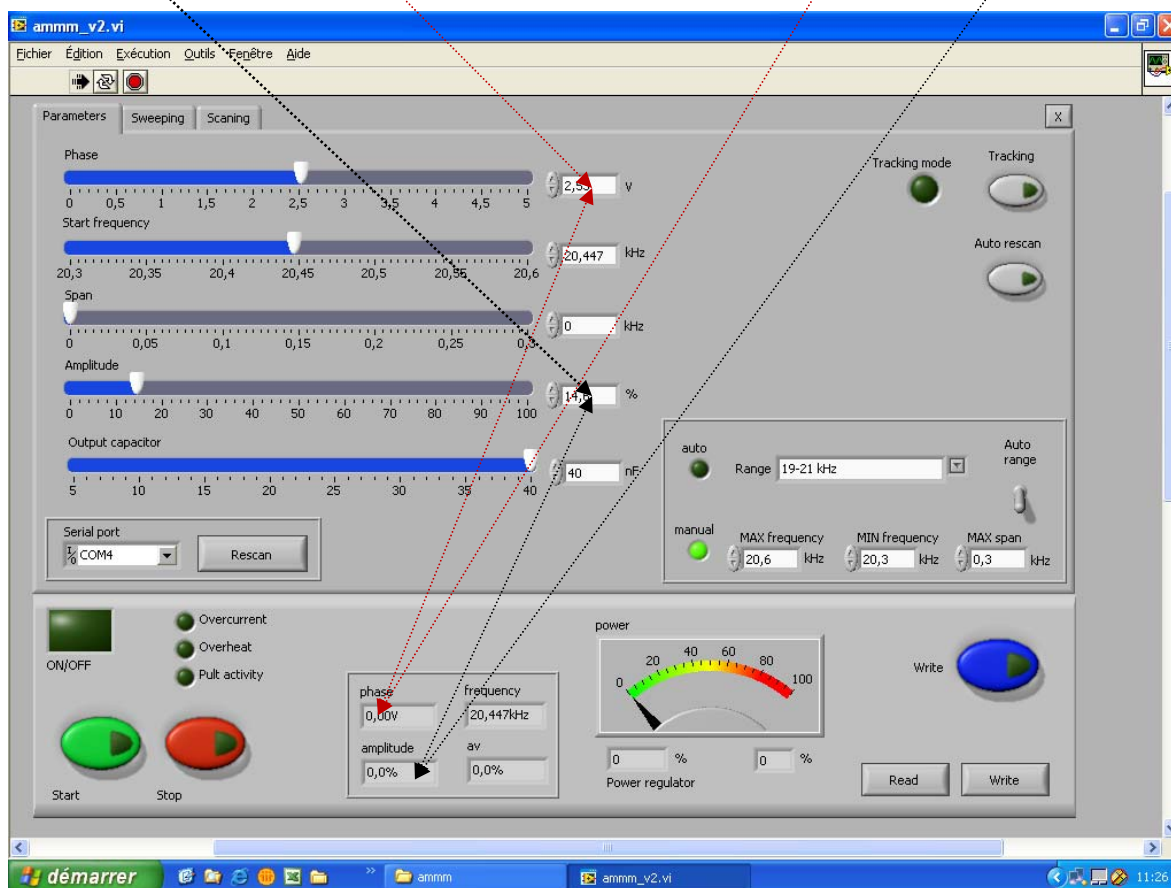

To achieve described automatic tracking the Phase set point, start frequency, compensating capacitance and frequency Span can be slightly readjusted in real time, during ultrasonic generator operating high power, until we reach desired operating amplitude regulation, while still keeping automatic phase regulation. These are very important and very useful options.

D) MIXED MODE

is the combination of **FREQUENCY-PHASE RESONANT TRACKING MODE** and **FORCED MODE** until certain level, as much ultrasonic load is able to accept and still operate smoothly and safely (without excessively generating heat dissipation and strange clipping and low frequency noise). In **MIXED MODE** dominant operating regime and regulation is the **RESONANT FREQUENCY-PHASE TRACKING MODE**, and **FORCED MODE** regulations are only slightly applied. Sonotrodes and ultrasonic loads which are specifically designed and well tuned to resonate on a fixed frequency are not easily (or not at all) accepting **MIXED MODE**. In order to use **MIXED MODE**, first make all settings and adjustments as for pure **RESONANT FREQUENCY-PHASE TRACKING MODE** (no load conditions, operating in air) and then try to apply (as much as reasonable and possible, depending on ultrasonic load bandwidth) certain level of frequency modulations (such as Sweeping, Smoothing, FSWM...), like in a **FORCED MODE**. Every ultrasonic transducer is able to accept certain frequency sweeping (but sometimes sweeping intervals will be very short: for instance 1 to 5 Hz in cases of high mechanical quality factors of well tuned ultrasonic loads).

Phase set point, start frequency and frequency Span can be later slightly changed in real time, during ultrasonic generator operating high power, until we reach desired operating amplitude regulation, while still keeping automatic phase regulation. These are very important and very useful options.

Read – Write options: After all settings are properly and optimally made and tested, we can save the file with such settings using **Write** button (like saving any PC file). Later, we can simply invite/**Read** one of such files (for a specific load) and AMMM generator will start operating as previously memorized.



Do not forget to activate cooling on ultrasonic converter (if operating in heavy duty conditions).

Monitor operating temperature on all oscillating parts (converter, booster, sonotrode) and if temperature is non-uniformly distributed and significantly increasing in certain zones, stop the generator and find reasons causing temperature rising (apply refastening, new scanning...).

Literature: [Piezoelectric Transducers Modeling and Characterization \(e-book\)](#)

ONLY FOR EXPERTS AND TRAINED BY MPI

Our ultrasonic power supplies, beside software settings, can also be internally adjusted to operate number of different ultrasonic transducers. For instance, if ultrasonic transducer has certain low or high, maximal, safe operating voltage (on piezoceramics), output generator voltage should be, and can be changed internally by selecting proper jumpers. In addition, internal compensating inductance could have different values, selectable by jumpers, in cases when effective, static capacitance of certain transducer is too low or too high (not covered by factory default settings).

We are not suggesting to our clients to play with such options, except if they are trained by MPI, and already well experienced in Ultrasonics R&D. They can get such training from MPI, and they anyway need to have specific test and measurement equipment (such as: an Oscilloscope with differential, floating inputs with amplitude gain from 1 to 1000 in order to measure low and very high RMS voltage, Impedance analyzer, R-L-C meter etc...).

See such jumpers' adjustable situations on the next three pages.

Internal output voltage and inductive compensation jumpers for 400 W generators

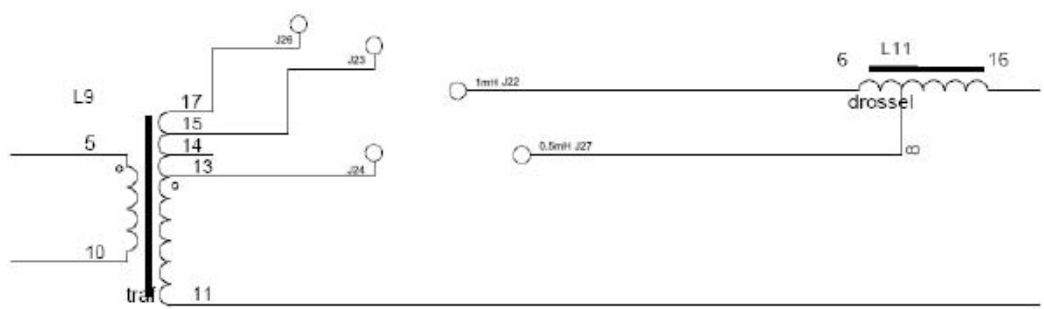
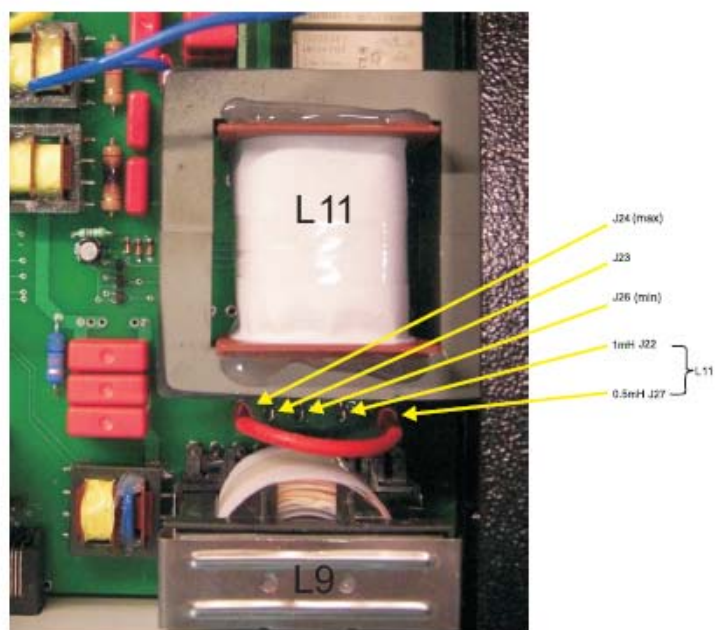
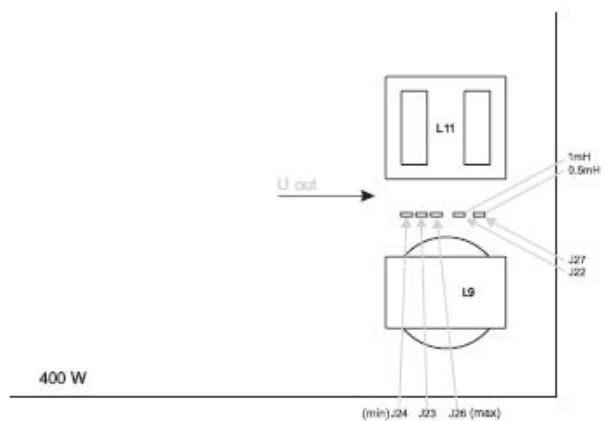

Internal output voltage and inductive compensation jumpers for 1kW generators

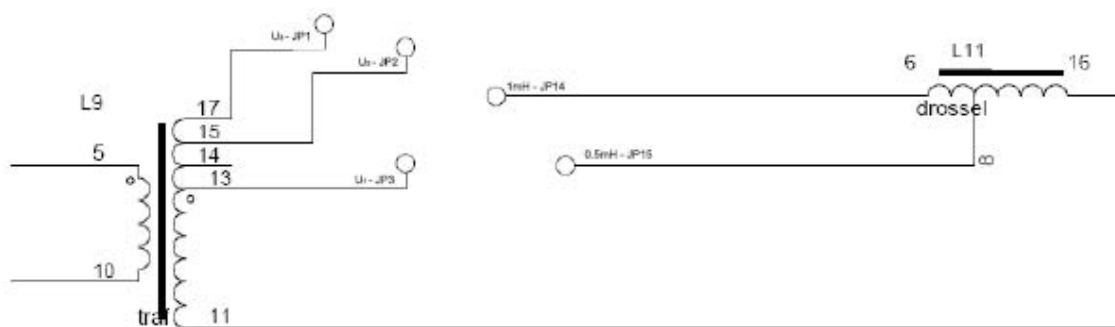
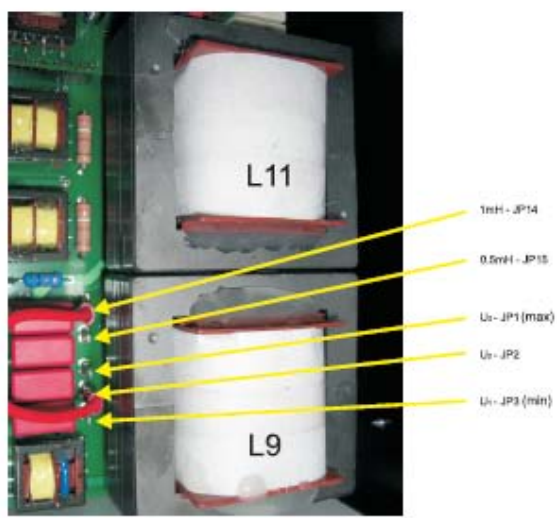
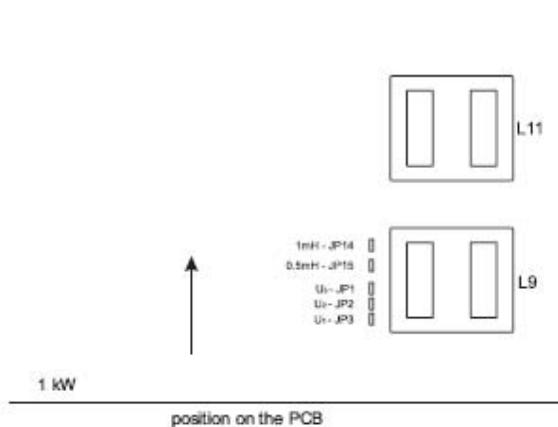

Internal output voltage and inductive compensation jumpers for 2 & 3 kW generators

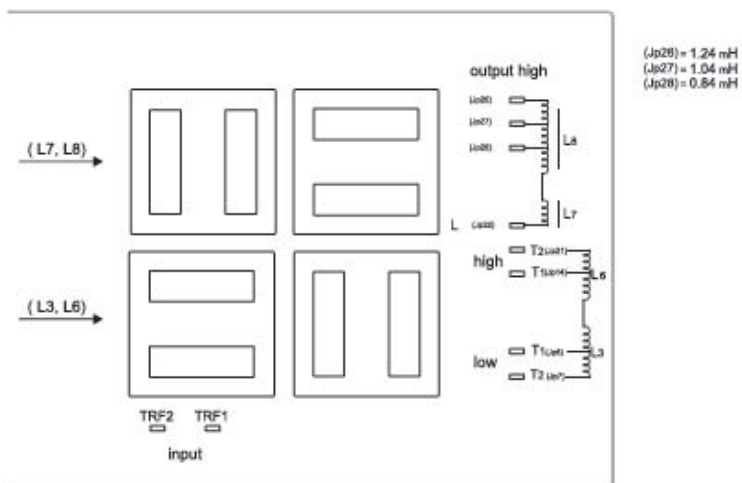

2 & 3 kW

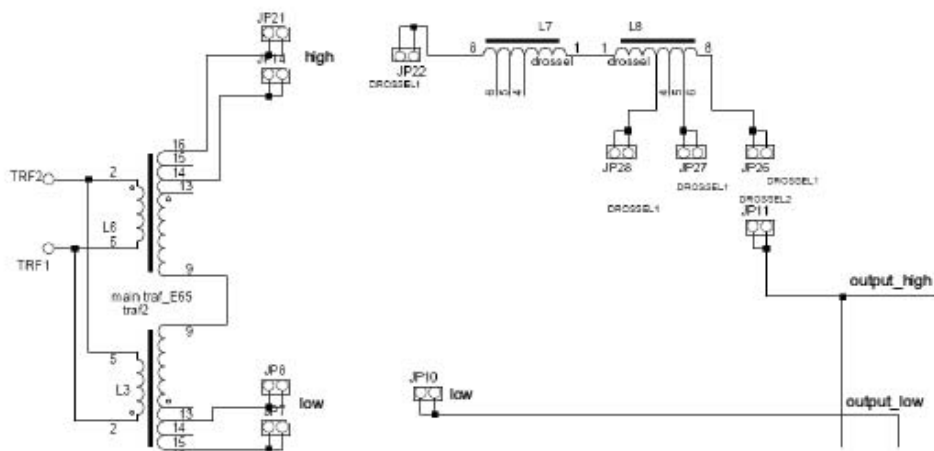
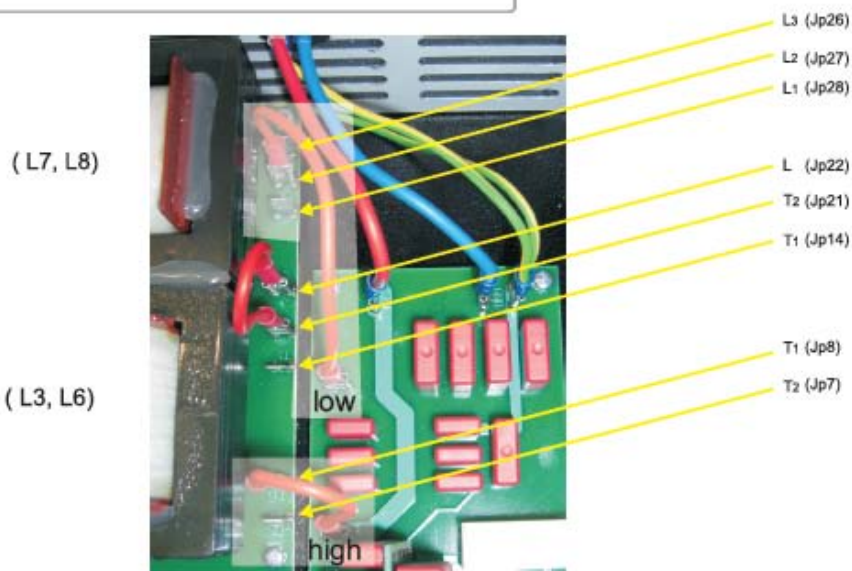

SAFETY INSTRUCTIONS

Before starting up your device, please read the following instructions carefully, both for your own safety and for the safety of the device.

Keep this manual where it can be readily accessed by all systems users.

Installation is to be carried out by qualified technical personnel only!

The ultrasonic generator is to be operated by properly trained personnel only!

Due to the way it operates, **additional** safety measures must be taken if the device is to be used in areas posing an explosion risk.

The electromagnetic compatibility corresponds to the standards and regulations listed in the specifications.

All necessary settings were either made in the factory or are described in this handbook.

However, should problems occur on start-up, please do not make any prohibited adjustments to the device, as this would endanger your warranty rights. If in doubt, please contact our technical service staff.

Please contact our technical service if you have any doubts or questions.

Work inside the device may only be carried out to the extent described and, as with the electrical connection, should only be performed by skilled personnel. When performing such work, the ultrasonic generator must be completely disconnected from the mains (unplug the mains connection).

Inputs or outputs that are used for controlling or monitoring purposes should be twisted and shielded.

The device must not be in close proximity to electrically charged components or cables.

The shielding should be connected to the generator's earth on one side of the generator.

Attention: All connections for the signal or control lines are in galvanic connection with the generator.

Always observe any warnings or instructions given on the device itself.

The device must always be disconnected from the mains before cleaning or when installing/uninstalling an option.

Do not use liquid cleaners or sprays. Only use a damp cloth.

The platform for the device must be sufficiently stable, as the device being jolted or falling could cause severe damage.

Ensure that the power supply specifications given on the device are met.

Only those transducers which have the correct frequency, power output and dimensions may be used with this generator.

HF cables from the generator to the transducer as well as mains cables to the generator may not be rolled up if they are too long. Instead, they must be shortened to the required length due to the risk of overheating.

With the exception of the permitted tasks listed in the handbook, you should never attempt to repair or modify the device yourself.

In the following cases, you should disconnect the device from the mains and contact a qualified service engineer:

- **If the mains cable or plug is damaged**
- **If liquid has penetrated into the device**
- **If the device has fallen over or the housing is damaged**
- **If the device displays noticeably different behavior than standard operation**

ATTENTION: Repairs and modifications may only be carried out by competent, skilled personnel.

ERROR MESSAGES AND TROUBLESHOOTING

The following error messages may appear in the display:

“OC” OVERCURRENT

The electronic over-current fuse has detected an error

Possible causes:

- Transducer is defective
- Power supply or plug is defective

Remedy:

- Unscrew the transducer connection on the housing
- Switch on the generator without the transducer connected

a) Error message still displayed:

Generator is defective

b) Error message no longer displayed:

Check the transducer and power supply

“OH” OVERHEATING

The electronic overheating fuse has detected an error

Possible causes:

- Not enough space around the generator.
- Working surroundings are too hot

MAINTENANCE

The ultrasonic generator does not need special maintenance.

Dust and dirt should be removed regularly using a damp cloth.

ATTENTION:

- **Do not use aggressive cleaning solvents!**
- **Not suitable for ultrasonic cleaning!**

WARRANTY

The length and coverage of the warranty can be found in the terms of delivery as part of the general terms and conditions (valid at the time of purchase) or in the sales contract / order confirmation, should any special agreements have been made.

The following cases are not covered by warranty:

- Damage caused by inappropriate operation
- The device not being used for its intended purpose
- Inappropriate alterations or modifications made without prior authorization from the manufacturer
- Damage caused by extreme circumstances, such as knocks, falling over, moisture and dirt
- Insufficiently qualified operating staff
- Non-compliance with current safety and accident-prevention regulations
- Damage resulting from modifications made to the operating instructions

SERVICE HOTLINE

Should you still have questions after reading through the operating instructions thoroughly, please feel free to call our service hotline.

Please have the following information ready to help us answer your questions quickly.

Device type, serial number (the serial number is on the backside of the generator)

SPARE PARTS

We can only deliver spare parts and accessories if you order them specifically.

Literature: [Piezoelectric Transducers Modeling and Characterization \(e-book\)](#)